

User Manual

Applicable Model: ZKX Series X-ray Inspection System

Version 3.2

April 2017

CONTENT

Statement of Rights and Responsibilities.....	1
Radiation Protection Statement.....	1
Contact.....	1
Foreword	2
Purpose	2
Applications.....	2
I . Safe Operation Instruction.....	3
1.1 Basic Safe Rules.....	3
1.2 Pre-check Before Start-up	3
1.3 Radiation Protection	3
II. Product Introduction	4
2.1 Working Principle.....	4
2.2 Technical Details & Basic Parameter.....	5
2.3 Product Features.....	6
2.4 Purpose & Applications.....	6
III. Operate Introduction.....	6
3.1 Check Before Start-up	6
3.2 Turn-on	6
3.3 Log in.....	7
3.4 Item Inspection.....	7
3.5 Shut Down	7
3.6 Indicator and Emergency Stop.....	7
IV. Software Introduction	8
4.1 Main Interface.....	8
4.2 Software Information District	9
4.3 Image Functions.....	9
4.4 Operation District.....	13
4.5 Menu & Shortcuts.....	14
V . Menu Operation.....	14
5.1 System Options.....	14
5.2 Image Management	14

5.3 User Management.....	16
5.4 Log Management.....	17
5.5 TIP.....	18
5.6 Training.....	19
5.7 System Settings.....	19
5.8 System Information.....	20
5.9 Log Out.....	20
5.10 Shut Down.....	20
VI. Maintenance.....	21
6.1 Daily Maintenance.....	21
6.2 Repair.....	21
6.3 Replace Rotating Drum and Conveyor Belt.....	22
6.4 Replace & Adjust Item Detect Sensor.....	22
6.5 Replace & Adjust X-ray Generator.....	22
6.6 Storage Conditions.....	22
VII. FAQ.....	22
7.1 Power Supply.....	23
7.2 System Control.....	24
7.3 X-ray Control.....	24
7.4 Image Display.....	25
VIII. Service.....	26
8.1 Principles.....	26
8.2 Device Acceptance.....	26
8.3 Technical Support and Training.....	26
8.4 Notice.....	26
ACCEPTANCE REPORT.....	27
QUALIFICATION.....	29
WARRANTY.....	30
WARRANTY CARD.....	31
TRAINING INFORMATION FORM.....	32
ACCEPTANCE LIST.....	33

Statement of Rights and Responsibilities

All rights reserved by ZKTeco Co. Ltd, and under the protection of relative Laws of People Republic of China. No person shall use the trademark without the express written permission of the company; no person may copy or spread this manual.

We are not responsible for breakdown caused by improper operation.

Due to product updates frequently, this manual may have differences from the actual product. Please prevail in kind.

We will not announce any further notice when we update the user manual.

Radiation Protection Statement

1.ZKX series X-ray inspection system meet the criterion of international and domestic radiation safety standard; it is harmless for human and environment.

2.ZKX series X-ray inspection system ensure ISO1600 (33DIN) Film safety.

Contact

Company: ZKTeco Co. Ltd.

Address: ZKTeco Industrial park, 188 Industrial Avenue, PingShan, TangXia town Dongguan, GuangDong province, China.

ZKTeco Building, Wuhe road, BanTian, LongGang district, Shenzhen.

Tel: 0769-82109991, 0755-89602345

Fax: 0769-82109990, 0755-89602394

Website: www.zkteco.com

Foreword

Dear customers, thank you for choosing ZKX-series X-ray inspection system. This manual will give instruction of operation safety, production instruction, image reading, menu option, FAQ and service. By this manual, you will learn how to operate, adjust and maintain this product. ZKX series follows the international safety standards of X-ray equipment. Thus, it is absolutely safe for operator and environment.

Purpose

This manual could help operator correctly operate ZKX series X-ray inspection system. Before you start, we strongly suggest you read this manual carefully.

Applications

This manual is applicable to:

- Operator
- Administrator
- Technician

I . Safe Operation Instruction

1.1 Basic Safe Rules

For safely use X-ray inspection system, please follow the following rules:

1. You should know relevant radiation protection rules.
2. The operator must know all safety instruction and rules.
3. If you had not used your device for more than 6 months, please check your device carefully before start up.
4. The installation, circuit connection and replacement of electrical components only could finish by professional technician.
5. If shell, cable or transmission belt are broken, no operation shall be allowed.
6. Only professional technician could open shell and inner parts.
7. Do not modify or change any safety settings.
8. No living things shall be allowed to go in X-ray inspection system.
9. Do not sit or stand on conveyor belt.
10. Do not dip any part of body into tunnel when device is running.
11. Immediately shut down if liquid flow into the device.
12. Do not block the thermovent.
13. All circuit connection and ground connection have to be completely correct.
14. Do not stand close to the entrance and exit of tunnel when device is running.

1.2 Pre-check Before Start-up

1. Check the lead film, do not start the device if there is broken or gap.
2. Check if item detect sensor are blocked.
3. Check if transmission belt deviate or stuck; ensure there is no spike or filth.
4. Check if there has flaw on the shell, monitor, console board and cable.
5. Ensure the cover plate is properly installed.

1.3 Radiation Protection

We take reliable radiation protection measures on our product to ensure the safety of operator and users, which are:

1. Only when generator under high voltage, device would emit X-ray, therefore, it would not generate radiation in transport and stock.
2. Lead boards are installed around the machine; entrance and exit have lead film, prevent X-ray from leaking into the environment.
3. Device has effective ground connection, prevent operators from electric shock.

4. The overload preventer, overcurrent preventer and current leakage preventer is installed inside the device.
5. A safe interlock is installed, if any interlock switch off, the X-ray generator would not be activated.

II. Product Introduction

2.1 Working Principle

X-ray inspection system has five parts: Item transmission part, X-ray source & control, signal sampling & transmission, Image processing and electric control.

Items entrance X-ray inspect tunnel by conveyor belt, an item detect sensor was installed at the entrance. When items go into the tunnel, the sensor would deliver an inspect action signal. Then control board controls the X-ray generator to generate the X-ray. The X-ray would penetrate items and partly absorbed by items, X-ray receiver would receive rest of X-ray. Then receiver transforms the X-ray into digital signal and send it to computer. With the superb image algorithm, clear image of item would display on the screen.

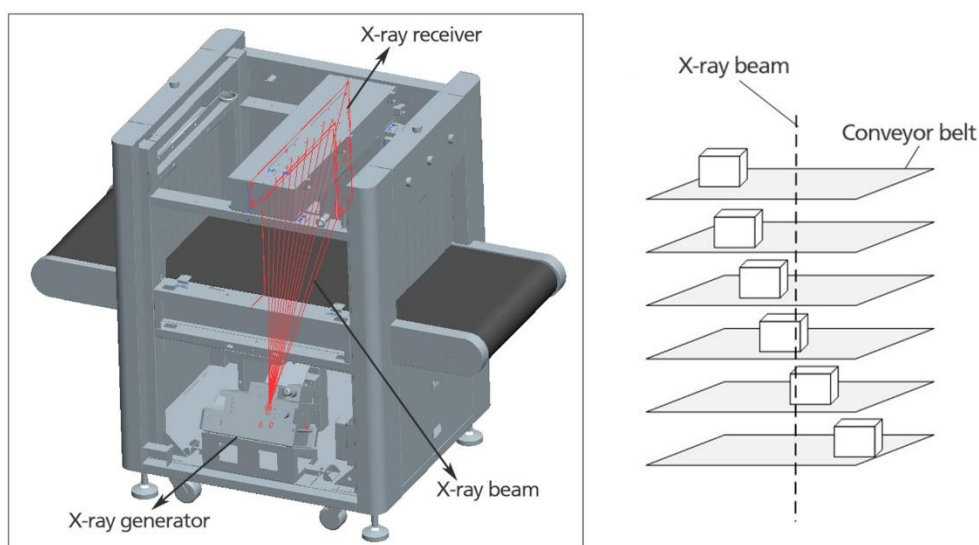

Figure 1 - Working principle

2.2 Technical Details & Basic Parameter

ZKX Series Parameter

Model			5030A	5030C	6040	6550	8065	10080	100100
			Single Energy	Dual Energy	Dual Energy	Dual Energy	Dual Energy	Dual Energy	Dual Energy
Basic Parameter	Tunnel Size (mm)	Width	500	500	600	650	800	1000	1000
		Height	300	300	400	500	650	800	1000
	Conveyor belt speed		0.2 m/s						
	Maximum Load (kg)		150	150	150	170	200	200	220
	Penetration (mm)		>10	>43			>34		
	Film Safety		Guarantee ISO1600 (33DIN) Film Safety Standard						
X-ray Generator	X-ray Direction		From bottom				From top		
	Tube Current (mA)		0.5 ~ 1.2						
	Tube Voltage (kV)		80~160						
	X-ray Emit Angle		60°	80°					
	Cooling		Sealed Oil Cooling						

1. Image Processing System

X-ray receiver: L-shaped phototube array detector. 8-bit depth.

Monitor: High resolution 17 inch.

Colorful image display: True-color or Pseudo-color (5030A) display.

Super Enhance: Image detail will be clearer.

High Penetration: Improve the contracts in light area.

Low Penetration: Improve the contracts in dark area.

Magnifier: Global zoom function.

Brighten/Darken: Increase/decrease the brightness.

Image Pull back: Pull back the image (≤ 50)

Image Recovery: Recovery to original image

Save: Save any image with processing

True-color: Organic displays as orange, Material displays as blue, Mixture displays as green.

2. Operating conditions

Running Temperature/ moisture: 0°C~40°C/20%~95%

Store temperature/ moisture: -20°C~60°C/20%~95%

Voltage: 220V, 50HZ

Power consumption: 1KW

2.3 Product Features

1. Radiation Protection: Lead curtain with protection film to prevent users from touching lead directly.
2. X-ray emit control: With item detect sensor, X-ray would be emitted only when an item goes onto tunnel.
3. One-stop shut down: Turn the key to off position, the device would shut down automatically and safely.
4. Fault automatically diagnosis: System will diagnose fault automatically and give failure messages.
5. Multifunctional console board: With a fingerprint reader to verify the identification of operators.

2.4 Purpose & Applications

X-ray inspection system uses the latest image technology, could detect dangerous items and high-density items. X-ray inspection system is widely used in Government, Exhibition center, Post office, hotel etc. It is applicable to detect small luggage, suitcase etc.

III. Operate Introduction

3.1 Check Before Start-up

1. Check the connection of power supply cable; check if power supply grounding is proper; and if the emergency button is pushed down. If emergency button is pushed down, clockwise rotate it to reset it.

Warning: If cable has any breakage or emergency stop button malfunction, please stop using device and contact Customer Service Department.

2. Check the lead film at the tunnel entrance. There should have no obvious gap or breakage.

Warning: If there have a huge gap or severe breakage on lead film, please stop using and contact customer service department.

3. Check if there is crank on belt's surface and the edges of belt should have equal distance to baffle, ensure there is no deviation or stuck.

Warning: If belt has obvious deviation, please adjust belt under professional guide.

4. Check if there is any item left in tunnel and remove it.

3.2 Turn-on

1. Insert the key to key switch, turn it to 'ON' position clockwise, push down start button (If emergency button was pushed down, need to push start button after reset).

2. System will run ZKScanner software automatically.

3. System will run preheating process automatically; preheating aim to protect the X-ray generator, and normally it will take 1-5mins. After preheating, device could start to do the scan work.

3.3 Log in

System will log in automatically an administrator account, default account is 9999, and password is 123456.

If you need to switch account, please log out and type other account and password.

3.4 Item Inspection

3.4.1 Item set

Lay item flat on the belt.

Attention: Thin item and dirty item should be put in plastic container. Avoid items block up at exit.

3.4.2 Item inspection

When an item goes into tunnel, monitor will display the scanning image of item. Different colors indicate different materials. The direction keys on the console board or software interface could control the moving direction of conveyor belt.

1. Push 'Forward' button.
2. Put item at the tunnel entrance.
3. When item goes through tunnel, the X-ray indicator (red light) turn on.
4. Remove item.

3.5 Shut Down

1. Stop running conveyor belt, turn the key to 'OFF' position, the power indicator on the right side of keyhole will turn off.
2. After one minute, device will give a beep sound, and yellow indicator light blinks, and then could cut off the power supply.
3. Safekeeping the key.

3.6 Indicator and Emergency Stop

3.6.1 Emergency stop button

If encounter emergency, push any emergency stop button to stop X-ray emitting and conveyor belt.

Notice: Rotate the emergency stop button to reset it, then push down the start button.

3.6.2 Power indicator (Green)

When device turns on, the power indicator will lighten.

3.6.3 X-ray indicator (Red)

When device is emitting X-ray, the X-ray indicator will lighten.

3.6.4 Alarm indicator (Yellow)

If automatic detect is activated, the alarm indicator will lighten when detect item that matches the detect alarm conditions.

Notice: This indicator will blink when device is shutting down.

IV. Software Introduction

4.1 Main Interface

The blank area will display the scanning image by scrolling.

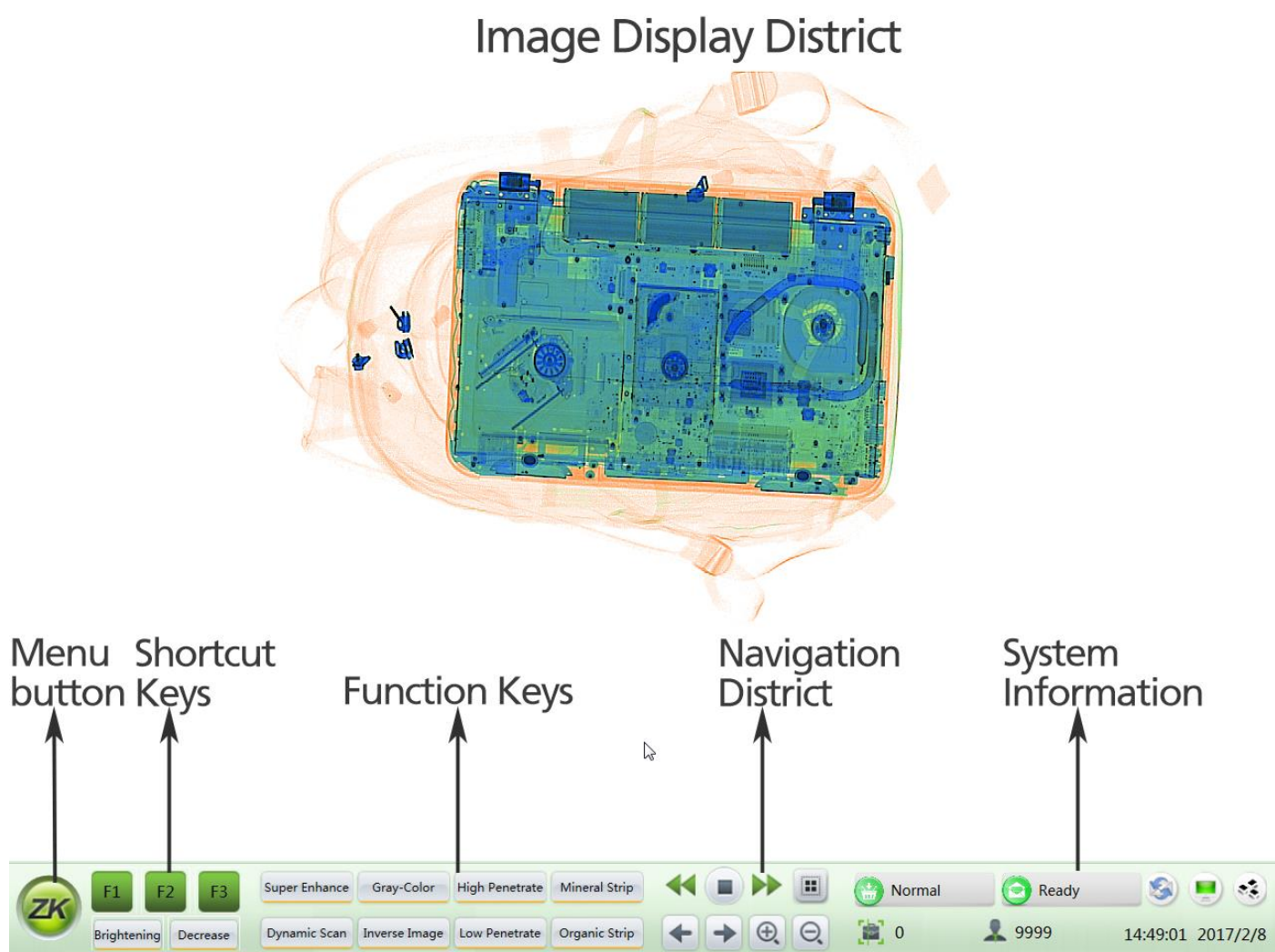

Figure 2 – Main Interface

4.2 Software Information District

4.2.1 Current user

System has two user groups, which are Administrators and Operators. They have different authorities.

4.2.2 Device status

1. Ready: When device is running properly, software will display Ready.
2. Scanning: When device is emitting X-ray, software will display Scanning.
3. Failure: When device encounter a failure, software will display Failure.
4. Emergency stop: When emergency stop button is pushed down or micro switch is activated, the software will display Emergency Stop Activated.

4.2.3 Package counter

Software will display the number of current user and time. It can display the package number in total as well.

4.2.4 Date & Time

Display the current date and time.

4.3 Image Functions

4.3.1 Grey-scale

All items will be displayed by 256 lightness levels. High-density material would be displayed by deeper color; low-density material would be displayed by lighter color.



Figure 3 - Grey-scale

4.3.2 Colorful display

In order to make inspection work easier, different materials would display as different colors. Inorganic is blue, organic is orange, mixture is green. High-density matter would show as black.

Type	Atomic Number	Typical Matter
Organic	≤ 10	Carbon, Hydrogen, Nitrogen, Oxygen compound
Mixture	10-18	Aluminum, Salt
Inorganic	> 18	Heavy metal



Figure 4 - Different colors of each materials (5030A right side)

4.3.3 High penetration

Improve the contrast of dark area.



Figure 5 - High Penetration (5030A right side)

4.3.4 Low penetration

Improve the contrast of light area.



Figure 6 - Low Penetration (5030A right side)

4.3.5 Super Enhance

This function would show the both of easy-penetrate items and hard-penetrate items at the same time. Even if the item hide between two metal boards, still could be showed clearly.

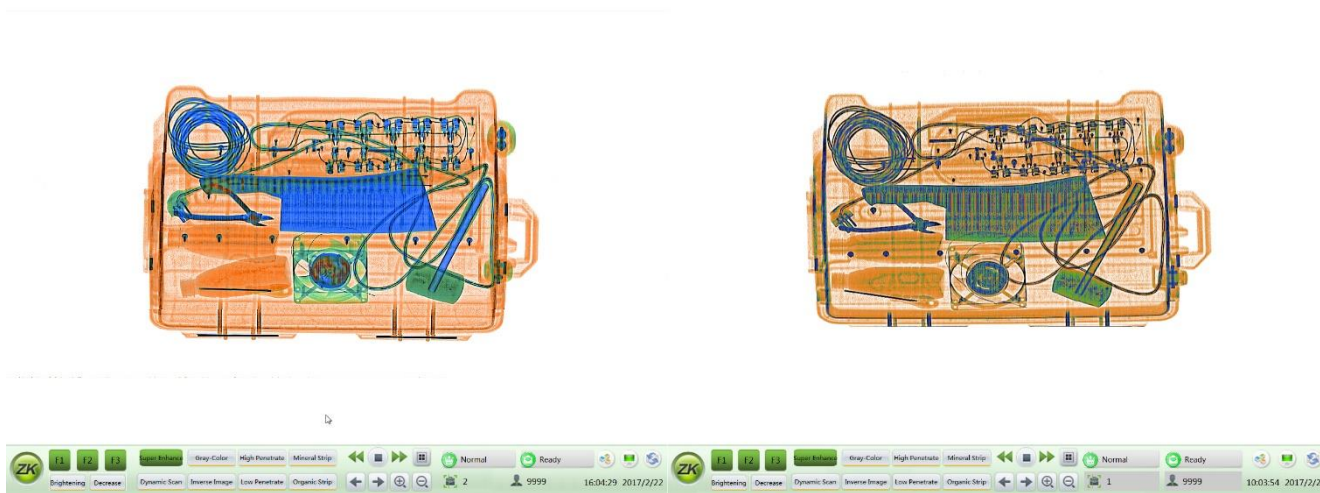

Figure 7 - Super Enhance (5030A right side)

4.3.6 Organic Strip (Only for Dual Energy machine)

Organic material would show as B&W.

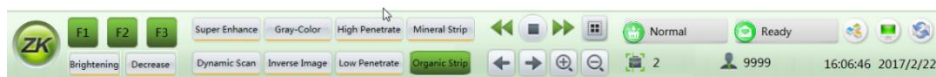
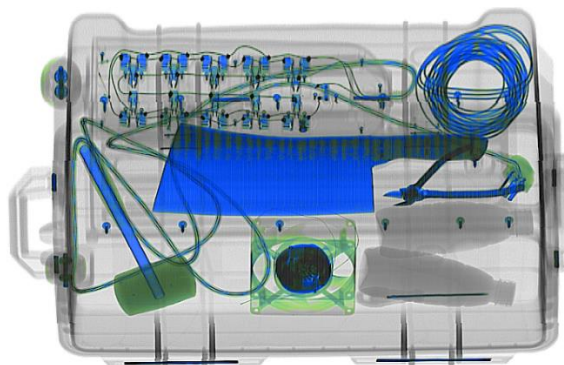

Figure 8 - Organic Strip

4.3.7 Inorganic Strip (Only for Dual Energy machine)

Inorganic material would show as B&W.

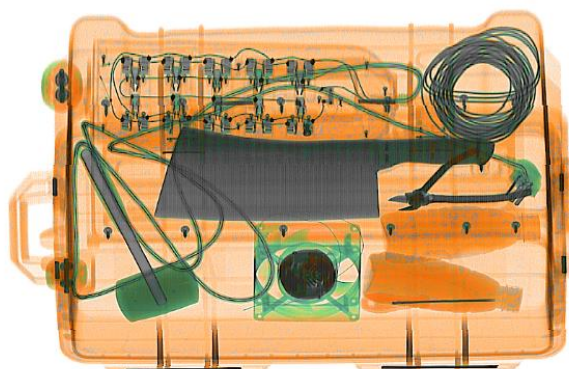

Figure 9 - Inorganic Strip

4.3.8 Image inverse

Invert colors function is applicable to observe the condensed cable.

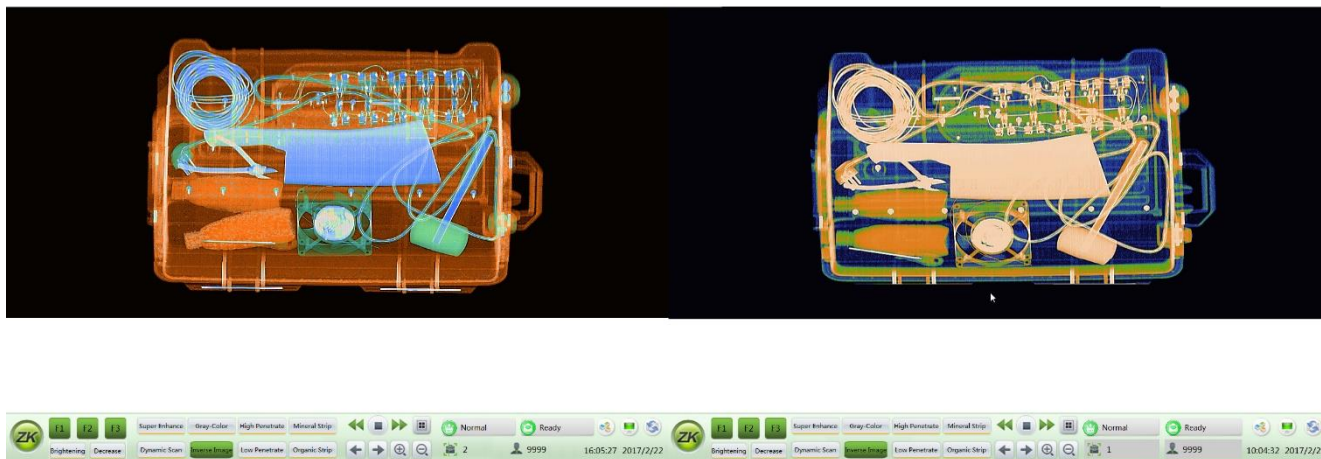

Figure 10 - Inverse (5030A right side)

4.3.9 Lighten/darker

Adjust the lightness of the scanning image.

4.3.10 Dynamic Scan

Image would display dynamically with this function.

4.4 Operation District

Could control conveyor belt moving forward, backward and stop moving. Also could zoom in/out picture, drag and recovery to the default status.

4.4.1 Recovery

Click  icon to recovery image to the original state.

4.4.2 Forward, Backward and Stop

Click  icon or push the navigation button, on the console board to make conveyor belt moving forward, backward or stop.

4.4.3 Drag

Click  icon or push the direction button on the control board to drag the image, it allows operator read former images.

4.4.4 Zoom in and zoom out

Click  and  or push the zoom button to zoom in and zoom out image. Could zoom in up to 32 times.

4.5 Menu & Shortcuts

4.5.1 Menu

Click icon or push the menu key on the console board to open menu.

4.5.2 Shortcuts

are shortcuts, could set them as different functions.

The default function of P1 is original picture.

The default function of P2 is Greyscale + Inverse.

The default function of P3 is Color + Inverse.

V. Menu Operation

5.1 System Options

System has two user groups, which are administrator and operator. Administrator and operator have different authorities, operator only could change image setting and modify password of current user, administrator could modify all settings except 'Device Maintenance'.



Figure 11 -- Menu

5.2 Image Management

5.2.1 Image Preview

Single click image list on left side, a thumbnail image would show on right side.

Image query: Finding former images.

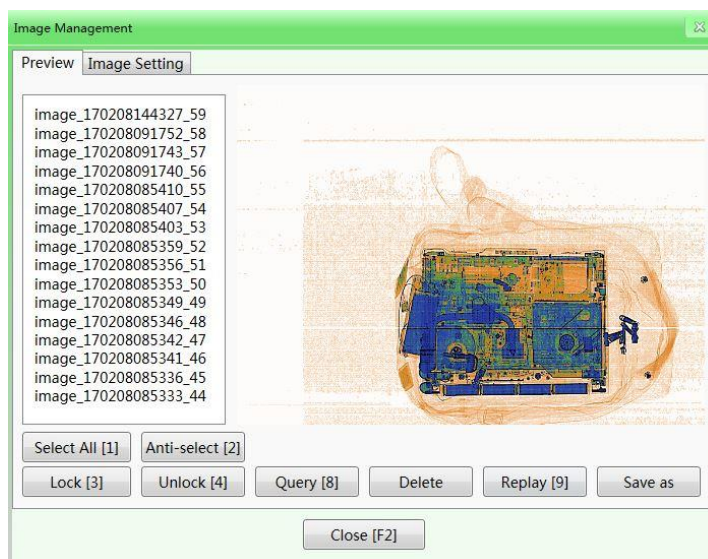

Figure 12 - Image Management

Notice:

1. User name: Select the user name to search the pics. Operator could only search the pics under its own name.

2. Term: Select start time and end time to search the pictures which the time interval.

Delete: Administrator could delete other users' pictures as well, except the locked pics.

Replay: Select replay to display the picture in main interface.

Save as: Click 'save as' to save image on your removable storage devices, image could save as BMP, JPG etc.

5.2.2 Image Setting

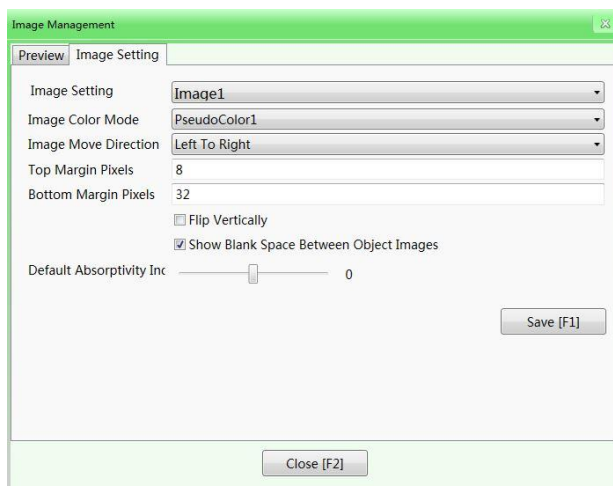

Figure 13 - Image Setting

Image setting: image1, image2 could make different settings to two monitors.

Image colors: The default color mode for scanning.

Notice: Single Energy model could not use colorful mode.

Image direction: Setting scroll direction of scanning image.

Flip vertical: The scanning image will flip vertically.

Blank area between two images: adjust the blank area between two scanning images.

Absorptivity: Absorptivity indicates that the ability item absorb the X-ray. The lower brightness will display when absorptivity is set in a high level.

5.3 User Management

Administrator could add and manage operator and reset log in password by this function, the operator only could modify password of current account.

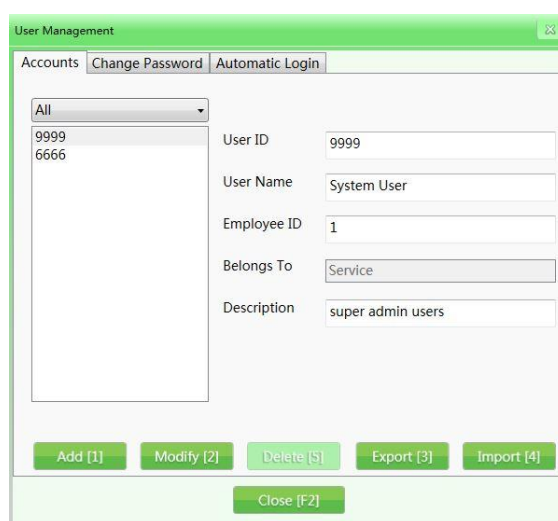

Figure 14 - User Management

5.3.1 Account settings

Add: Click 'add' to add a new operator account.

Modify: Click 'modify' to change information of account.

Delete: Click 'delete' to delete account.

Import/Export: This function allows administrator to import/export the account group information (only for ZKX Series, document type is HTML).

Notice:

1. User name and password both are six figure number.
2. Administrator only could reset the password of operators rather than modify them. The default password is 123456.
3. The account that be deleted could not recover.

5.3.2 Modify password

The default password for a new account is 123456.

If need to modify the password, please enter elder password then type a new one. The password only could be set as six-figure number.

5.3.3 Automatic log in

Set default automatic log in account.

5.4 Log Management

This function only open to Administrator, could search running record of device. Including 'Startup log', 'Session log', 'X-ray radiation log'.

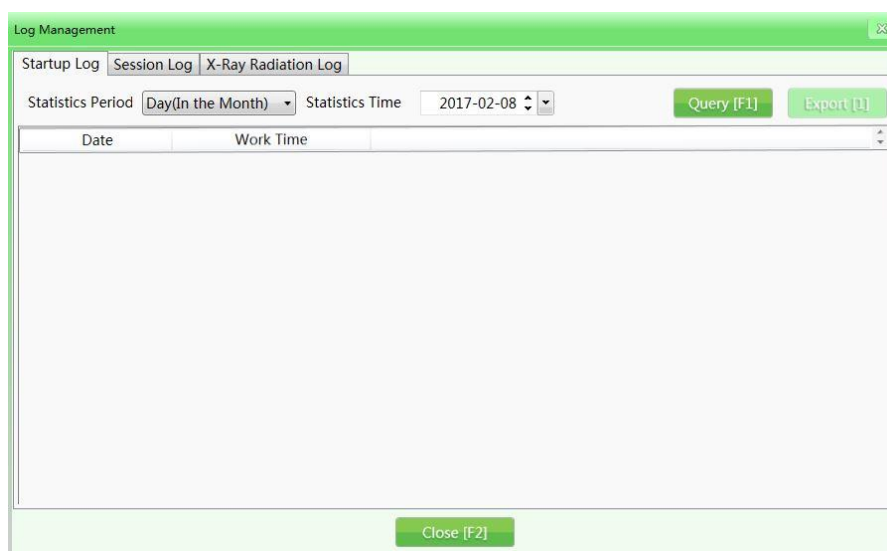

Figure 15 - Log Management

5.4.1 Startup log

Recording running time of device: could search by Day, Month, Season and Year.

Statistic time indicates the start time in each period.

Export record: user could click single or several records to choose records that need to export. The data will export as CSV file.

5.4.2 Session log

Take operator as unit, record the working time of each operator. System will record the start time and end time of each operator's working period.

User name: choose specific user or select all users.

Statistics period: same as Running log, Working log also could search by Day, Week, Month and Year.

Notice: the '2017-02' under the week search indicates the second week of 2017.

5.4.3 X-ray radiation log

Record the X-ray emit time of device.

5.5 TIP

System offers TIP function, which based on the weight of different type of dangerous items, then insert the dangerous items image randomly into normal work to improve the reaction velocity of operator. Administrator could create a new strategy, also could set name/ priority/ start time/ end time and activate or not. Furthermore, also could choose which type of account this strategy is for. Also, could set proportion of TIP image by 'Projection Percent', set reaction time by 'Dynamic Judgement Time'. 'Static Judgement Time' could set the static time when a TIP image appears.

Basic Information

Strategy Name: 124 Enabled

Priority Level(1-10): 5

Begin Time: 2016-05-01 18:34:54

End Time: 2016-12-01 18:34:54

User Role Category: Admin

Projection Percent(%): 100

Dynamic Judgment Time(3-6s): 4

Static Judgment Time(3-20s): 6

TIP Type Projection Weight Setting

TIP Type	Projection Weight(0-10)
Knife	10
Gun	0
Explosive	0
Cash	0
Fruit	0
Other	0

OK [F1] Cancel [F2]

Figure 16 - TIP

5.5.1 TIP image

System has a gallery of TIP image, which list all dangerous item pictures, also could import new picture. (Only support import ZKX file)

5.5.2 TIP result check

System would record the TIP result of each operator. The result would be recorded after log out the current account.

5.6 Training

Training function does not need to emit X-ray. It could display dangerous items by sequence or randomly. Operator could improve reaction time and accuracy by this function. Administrator could set image interval time (0-120s), Training mode indicates that the image display mode, including single, sequence and randomly. Select folder indicates user could select a folder to display all pictures inside.

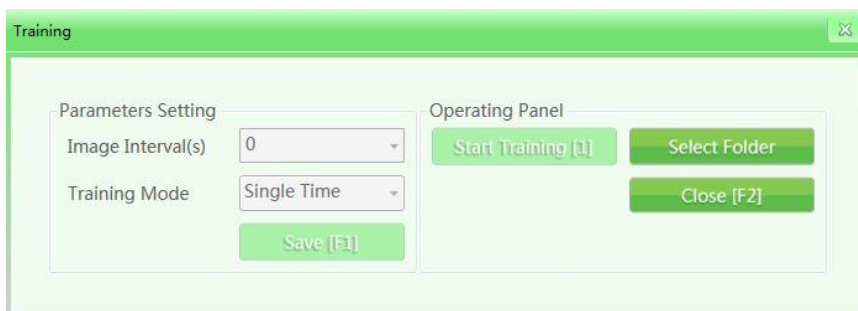

Figure 17 - Training

Notice: conveyor belt would not run under the Training mode.

5.7 System Settings

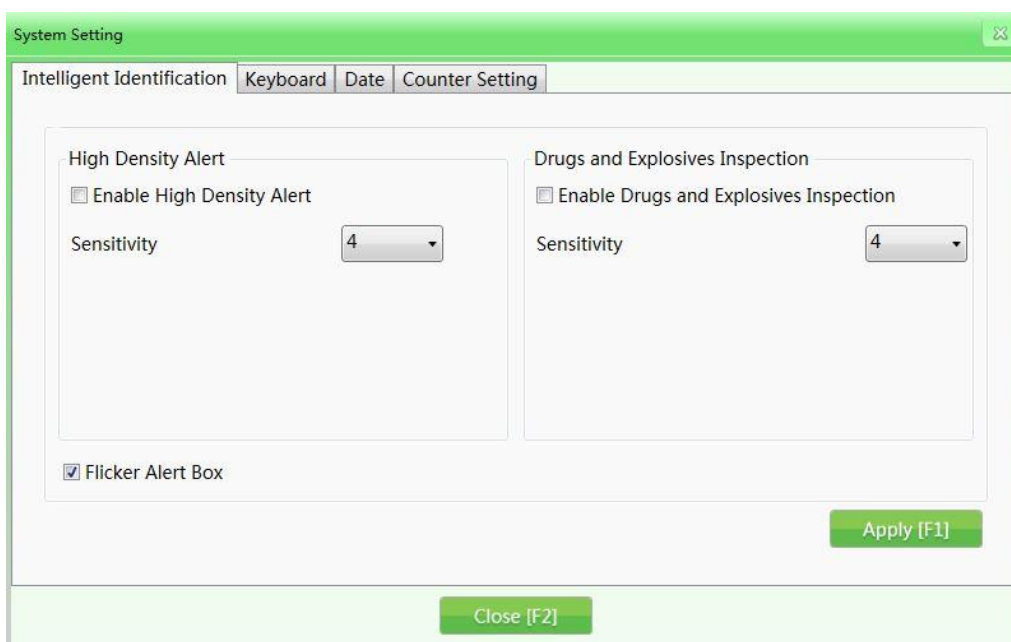

Figure 18 - System Setting

5.7.1 Intelligence recognition

'High Density Alert' and 'Drug & Explosive Inspection' could be chosen. The sensitivity could be adjusted as well. Higher sensitivity indicates easier to activate alarm.

However, system could not ensure the accuracy of estimation. Suspicious item should take an analysis of material composition by professional organization or device.

5.7.2 Keyboard

In 'Keyboard' tab, could define the function combination of three shortcut keys.

5.7.3 Date

In 'Date' tab, could set the time of system.

5.7.4 Counter

In 'Counter' tab, could search the item number, also could choose display the total number or the temporary items number.

5.8 System Information

In 'System info' tab could check disk space and running time etc.



Figure 19 - System Information

5.9 Log Out

Click Log out button in menu.

5.10 Shut Down

Click shut down button then turn the key to off position. Device would completely shut down after a beep sound.

Notice:

1. Turn the key to 'OFF' position to ensure cut off the power supply of control board, X-ray generator and conveyor belt.
2. Ensure no item had left in tunnel.

VI. Maintenance

6.1 Daily Maintenance

The maintenance engineer need to be certified by ZKTeco.

The maintenance operation needs to execute only when power supply is cut off.

6.1.1 Normal maintenance

- Device should install in well-ventilated, clean and dry environment. Avoid direct sunlight, high temperature and high moisture.
- Remove dust before maintenance.
- Fasten components when find it is loose.
- Replace stain components when necessary.
- Avoid liquid goes into device.

6.1.2 Specific contents of maintenance

- Check power indicator: when device turns on, green indicator lighten.
- Check X-ray indicator: when device emits X-ray, red indicator lighten.
- Check emergency stop button: when button is pushed down, power supply cut off immediately. Device could not start again without resetting emergency stop button.
- Check key switch on the console board: Replace key switch if it becomes insensitive.
- Check item detect sensor at entrance: check if X-ray emit normally. Clean the sensor lens and glass on the tunnel wall.
- Check transmission system check if conveyor belt could running normally, check if there is abnormal noise and without oil leaking.
- Check micro switches: remove covering plate and then X-ray stop emitting.
- Check conveyor belt: ensure belt do not have deviation.
- Check thermovent: ensure no shelter from thermovent and remove the dust.

6.2 Repair

- Only professional technician could do repair operations.
- Ensure no liquid or extraneous matter goes into device.
- Many 220V components contained, do operations after cut off power supply. If need to repair when power is on, ensure well electrical hazard protection and operate by professional technicians.
- Device contains lead to prevent radiation from leaking, wear gloves when do maintenance and repair. If operate maintenance or repair without wearing gloves, wash hands carefully after operating.
- Install covering plate to original place when repair work finished.

6.3 Replace Rotating Drum and Conveyor Belt

- Cut off the power supply and disconnect the motor cable.
- Remove covering plate of two sides, screw off the fasten bolt, remove the conveyor.
- Loose tension bolt, repair or replace the rotating drum and conveyor belt.

6.4 Replace & Adjust Item Detect Sensor

- Cut off the power supply and remove covering plate of two sides.
- Disconnect the item detect sensor cable.
- Screw off two fasten bolts of item detect sensor.
- Replace new sensor, move it up or down slightly to the proper position, and then fasten it.
- Weld a connector at cable exit according to drawing.
- Connect the cable and install the covering plate.
- Turn on the device and test if device could emit X-ray normally.

6.5 Replace & Adjust X-ray Generator

- Cut off the power supply and remove covering plate of two sides.
- Disconnect the X-ray generator cable.
- Screw off the fasten bolt, remove the spacing block, loose the adjusting bolt.
- Remove the X-ray generator and install a new one, do not fasten the bolt and spacing block.
- Connect all cables and install the covering plates.
- Turn on the device and observe the energy waveform of X-ray.
- Cut off the power supply of X-ray generator and adjust the position.
- Fasten the bolt and spacing block.

6.6 Storage Conditions

The storage environment should be clean and dry, avoid high temperature and moisture. If need long-term storage, put device back to the original packing box.

VII. FAQ

This chapter gives an introduction of common faults, reasons and solutions. Please use spare components offered by ZKTeco to finish all maintenance and repair job. ZKTeco is not responsible for faults caused by unauthorized components.

Reaffirm: repair operation should execute by professional technician.

7.1 Power Supply

Fault 1: Device could not turns on

Possible reasons:

1. Local power supply

Solution: Ensure local power supply accord to 220+10% /-15%, 50±3 Hz.

2. Did not turn the key switch on

Solution: Insert the key to key switch and turn on.

3. Fuse breakdown

Solution: Replace a new fuse.

4. Breaker switching off

Solution: Switch on the breaker.

5. Emergency stop button is pushed down

Solution: reset the emergency stop button.

6. Connecting terminal dropped

Solution: Connect the terminal.

Fault 2: Power indicator does not lighten

Possible reasons:

1. Indicator cable is disconnected

Solution: Connect the cable.

2. Indicator breakdown

Solution: Replace the indicator

Fault 3: Device does not work under the correct power supply

Possible reasons:

1. Controller disconnected

Solution: Connect the controller.

2. KM2 contactor breakdown

Solution: Replace a new contactor.

3. Power switch breakdown

Solution: Replace a new power switch.

4. LAN cable disconnected

Solution: Connect the LAN cable.

5. Serial port line disconnected

Solution: Connect the serial port line to IPC.

7.2 System Control

Fault 1: Conveyor belt could not run

Possible reasons:

1. RS232 cable disconnected

Solution: connect the RS232 cable.

2. Electrical controller breakdown

Solution: Replace electrical controller.

3. Starting electric capacitor breakdown

Solution: Replace a new starting electric capacitor.

4. Conveyor cable disconnected

Solution: Connect conveyor cable.

5. Rotating drum breakdown

Solution: Replace a new rotating drum.

6. Conveyor belt stuck

Solution: Adjust conveyor belt.

Fault 2: Conveyor could not be stopped

Possible reasons:

1. Electrical controller breakdown

Solution: Replace a new electrical controller.

2. CPU malfunction

Solution: Restart device.

7.3 X-ray Control

Fault 1: X-ray could not emit

Possible reasons:

1. Item did not activate the item detect sensor

Solution: Put an opaque item has enough volume to activate sensor.

2. Covering plate was open

Solution: Install the covering plate.

3. Power of X-ray generator controller disconnect

Solution: Connect the X-ray generator controller power supply.

4. AC contactor breakdown

Solution: Replace a new KM2 AC contactor.

5. X-ray generator breakdown

Solution: Replace a new X-ray generator.

6. X-ray generator cable incorrectly connect

Solution: Reconnect X-ray generator cable.

7. Item detect sensor incorrectly connect

Solution: Reconnect the item detect sensor.

8. Item detect sensor breakdown

Solution: Replace a new item detect sensor.

9. Electrical controller breakdown

Solution: Replace a new electrical controller.

7.4 Image Display

Fault 1: Monitor could not switch on

Possible reasons:

1. Power supply of monitor disconnected

Solution: Reconnect the monitor.

2. Monitor signal cable disconnected

Solution: Reconnect the signal cable.

Fault 2: Monitor displays vertical stripe

Possible reasons:

1. Signal process board breakdown

Solution: Replace a new signal process board.

2. Cable disconnected

Solution: Reconnect cable or replace a new cable.

Fault 3: No scanning image display

Possible reasons:

1. The cable between control board and IPC disconnected

Solution: Reconnect or replace a new cable.

2. Control board breakdown

Solution: Replace a new control board.

3. Item detect sensor breakdown

Solution: Replace a new item detect sensor.

Fault 4: Monitor displays horizontal stripe

Possible reasons:

1. X-ray receiver breakdown

Solution: Replace a new X-ray receiver.

VIII. Service

8.1 Principles

ZKTeco dedicated to provide quality services to customers.

8.2 Device Acceptance

1. User should inform ZKTeco when receive the device, ZKTeco would arrange a professional technician to offer assistance. Technician should assist user to inform ZKTeco to offer after-sales service.
2. During the device test, user should give cooperation to technician.
3. Device acceptance standard: according to the rules and method in contract.
4. Time limit of acceptance: Finish the acceptance in 5 days that receive device, user should sign up the acceptance report; the date should be the starting day of warranty period. ZKTeco would not be responsible if user exceed the time limit.

8.3 Technical Support and Training

ZKTeco offers training course to user free.

1. Purpose: to ensure user comprehend the consist of device, and give an introduction of basic operation. Meanwhile, user should give an estimation to device.
2. Time: base on user's demand.
3. Location: ZKTeco should host a training on site in principle.

8.4 Notice

ZKTeco does not offer after-sales services in following situation:

1. The nameplate or serial number of device or components is smashed or obliterated.
2. Damage caused by improper operation, repair or storage.
3. Damage caused by force majeure.
4. Once repaired by unauthorized organization or person.
5. Replace components did not offer by ZKTeco, unless acquire written authorization in advance.

ACCEPTANCE REPORT

Serial	Name	Model	Number	Note
1	Type	<input type="checkbox"/> 5030A; <input type="checkbox"/> 5030C; <input type="checkbox"/> 6040; <input type="checkbox"/> 6550; <input type="checkbox"/> 8065; <input type="checkbox"/> 10080; <input type="checkbox"/> 100100. <input type="checkbox"/> _____.		
2	IPC	<input type="checkbox"/> Standard IPC		
3	Monitor	<input type="checkbox"/> 17inch; <input type="checkbox"/> 19inch; <input type="checkbox"/> _____.		
4	Console board	<input type="checkbox"/> Console board;		
5	Backup keyboard/mouse	<input type="checkbox"/> Wireless suit; <input type="checkbox"/> _____		
6	Tool box	<input type="checkbox"/> Adjustable wrench; <input type="checkbox"/> Allen wrench; <input type="checkbox"/> 2 Phillips screwdrivers; <input type="checkbox"/> Slotted screwdriver; <input type="checkbox"/> Bench vice; <input type="checkbox"/> Diagonal pliers; <input type="checkbox"/> Long nose pliers; <input type="checkbox"/> White gloves; <input type="checkbox"/> 2 Starting Keys; <input type="checkbox"/> Cutter; <input type="checkbox"/> 12 Fasten bolts for rack; <input type="checkbox"/> 2 Triangle Keys <input type="checkbox"/> 10 Ribbons; <input type="checkbox"/> 4 Console desk keys; <input type="checkbox"/> _____.		
7	Manual	<input type="checkbox"/> User manual;		
8	Qualification	<input type="checkbox"/> Qualification;		
9	Warranty	<input type="checkbox"/> Warranty;		
10	Acceptance list	<input type="checkbox"/> Acceptance list;		

11	Warranty card	<input type="checkbox"/> Warranty card;		
12	Packing list	<input type="checkbox"/> Packing list;		
13	Rack	<input type="checkbox"/> 5030; <input type="checkbox"/> 6040; <input type="checkbox"/> 6550; <input type="checkbox"/> 8065; <input type="checkbox"/> 10080/100100; <input type="checkbox"/> _____.		
14	Console desk	<input type="checkbox"/> 17inch single monitor; <input type="checkbox"/> 19inch single monitor; <input type="checkbox"/> 17inch double monitors; <input type="checkbox"/> 19inch double monitors; <input type="checkbox"/> _____.		

Date: _____ **Signature:** _____

QUALIFICATION

Name: X-ray security inspection system

Model:

Serial number:

This model is according to 'GB15208.1-2005' standard.

Conclusion: Qualified

Inspector:

Date:

WARRANTY

The model as following:

5030A Number:

5030C Number:

6040 Number:

6550 Number:

8065 Number:

10080 Number:

100100 Number:

_____ Number:

Please use as User Manual's instruction.

WARRANTY CARD

When your device encounter a trouble, write your information in the form below and fax to us, we would like to arrange a technician to offer service. We appreciate your cooperation!

Address:		
Model:	Number:	
Model:	Number:	
People in charge:	Duty:	Contact:
Activate time:		
Trouble description in detail :		

Date:

ACCEPTANCE LIST

Model	User name
Examine content:	
1. Device information	
Model _____ Serial number _____	
2. Parameter	
Voltage(AC)	V Frequency Hz
Power	KW
3. Function	
Power indicator	[] X-ray indicator [] Cooler []
Emergency stop	[] Key switch []
Item detect sensor	[] Pre-heating [] Mouse []
4. Software	
1. User management:	
Log in	[] Log out [] Add/ Delete []
2. Image management:	
Search	[] Replay [] Save as []
3. Information collect and control:	
Low-speed communication	[] Hi-speed information collect []
4. Self diagnostics:	
Self diagnostics	[] Receiver waveform [] X-ray generator []
Item detect sensor	[]
5. Scanning image:	
Inorganic/blue	[] Organic/orange [] Mixture/Green []
Image display	[]
6. Image process functions:	
Edge enhance	[] Super enhance [] High-density alarm []
Organic/Inorganic	[] Adjustable absorb [] High/Low penetration []
Reverse	[] B&W/Colorful [] Zoom in/out []
Recovery	[] Pull back [] Shortcut []

5. Structure:

Motor function normal[] Belt running well[] Lead film normal[]Appearance [] Transmission []

Appraise:

Does technician work on time? Y [] N []Do you reach what you expected? Y [] N []Are you satisfied with technician's ability? Y [] N []How do you feel about our product? Satisfied[] Unsatisfied[]

Conclusion:

By the two sides of the field to test:

1.Equipment is complete []2.Device is working normally []3.Finish the staff training []

4.Suggestions:

Signature/Date:

Date of technician adjust on site