

# User Manual

## ZK-IWBM

Date: August 2023

Doc Version: 1.0

English

Thank you for choosing our product. Please read the instructions carefully before operation. Follow these instructions to ensure that the product is functioning properly. The images shown in this manual are for illustrative purposes only.



For further details, please visit our Company's website  
[www.zkteco.com](http://www.zkteco.com).

## Copyright © 2023 ZKTECO CO., LTD. All rights reserved.

Without the prior written consent of ZKTeco, no portion of this manual can be copied or forwarded in any way or form. All parts of this manual belong to ZKTeco and its subsidiaries (hereinafter the "Company" or "ZKTeco").

## Trademark

**ZKT<sub>ECO</sub>** is a registered trademark of ZKTeco. Other trademarks involved in this manual are owned by their respective owners.

## Disclaimer

This manual contains information on the operation and maintenance of the ZKTeco equipment. The copyright in all the documents, drawings, etc. in relation to the ZKTeco supplied equipment vests in and is the property of ZKTeco. The contents hereof should not be used or shared by the receiver with any third party without express written permission of ZKTeco.

The contents of this manual must be read as a whole before starting the operation and maintenance of the supplied equipment. If any of the content(s) of the manual seems unclear or incomplete, please contact ZKTeco before starting the operation and maintenance of the said equipment.

It is an essential pre-requisite for the satisfactory operation and maintenance that the operating and maintenance personnel are fully familiar with the design and that the said personnel have received thorough training in operating and maintaining the product/unit/equipment. It is further essential for the safe operation of the product/unit/equipment that personnel has read, understood and followed the safety instructions contained in the manual.

In case of any conflict between terms and conditions of this manual and the contract specifications, drawings, instruction sheets or any other contract-related

documents, the contract conditions/documents shall prevail. The contract specific conditions/documents shall apply in priority.

ZKTeco offers no warranty, guarantee or representation regarding the completeness of any information contained in this manual or any of the amendments made thereto. ZKTeco does not extend the warranty of any kind, including, without limitation, any warranty of design, merchantability or fitness for a particular purpose.

ZKTeco does not assume responsibility for any errors or omissions in the information or documents which are referenced by or linked to this manual. The entire risk as to the results and performance obtained from using the information is assumed by the user.

ZKTeco in no event shall be liable to the user or any third party for any incidental, consequential, indirect, special, or exemplary damages, including, without limitation, loss of business, loss of profits, business interruption, loss of business information or any pecuniary loss, arising out of, in connection with, or relating to the use of the information contained in or referenced by this manual, even if ZKTeco has been advised of the possibility of such damages.

This manual and the information contained therein may include technical, other inaccuracies or typographical errors. ZKTeco periodically changes the information herein which will be incorporated into new additions/amendments to the manual. ZKTeco reserves the right to add, delete, amend or modify the information contained in the manual from time to time in the form of circulars, letters, notes, etc. for better operation and safety of the product/unit/equipment. The said additions or amendments are meant for improvement /better operations of the product/unit/equipment and such amendments shall not give any right to claim any compensation or damages under any circumstances.

ZKTeco shall in no way be responsible (i) in case the product/unit/equipment malfunctions due to any non-compliance of the instructions contained in this manual (ii) in case of operation of the product/unit/equipment beyond the rate limits (iii) in case of operation of the product and equipment in conditions different from the prescribed conditions of the manual.

The product will be updated from time to time without prior notice. The latest operation procedures and relevant documents are available on <http://www.zkteco.com>.

If there is any issue related to the product, please contact us.

## ZKTeco Headquarters

**Address**      ZKTeco Industrial Park, No. 32, Industrial Road,  
Tangxia Town, Dongguan, China.

**Phone**        +86 769 - 82109991

**Fax**            +86 755 - 89602394

For business related queries, please write to us at: [sales@zkteco.com](mailto:sales@zkteco.com).

To know more about our global branches, visit [www.zkteco.com](http://www.zkteco.com).

## About the Company

ZKTeco is one of the world's largest manufacturer of RFID and Biometric (Fingerprint, Facial, Finger-vein) readers. Product offerings include Access Control readers and panels, Near & Far-range Facial Recognition Cameras, Elevator/Floor access controllers, Turnstiles, License Plate Recognition (LPR) gate controllers and Consumer products including battery-operated fingerprint and face-reader door locks. Our security solutions are multi-lingual and localized in over 18 different languages. At the ZKTeco state-of-the-art 700,000 square foot ISO9001-certified manufacturing facility, we control manufacturing, product design, component assembly, and logistics/shipping, all under one roof.

The founders of ZKTeco have been determined for independent research and development of biometric verification procedures and the productization of biometric verification SDK, which was initially widely applied in PC security and identity authentication fields. With the continuous enhancement of the development and plenty of market applications, the team has gradually constructed an identity authentication ecosystem and smart security ecosystem, which are based on biometric verification techniques. With years of experience in the industrialization of biometric verifications, ZKTeco was officially established in 2007 and now has been one of the globally leading enterprises in the biometric verification industry owning various patents and being selected as the National High-tech Enterprise for 6 consecutive years. Its products are protected by intellectual property rights.

## About the Manual

This manual introduces the operations of **ZK-IWBM Series**.

All figures displayed are for illustration purposes only. Figures in this manual may not be exactly consistent with the actual products.





## Document Conventions

Conventions used in this manual are listed below:

### GUI Conventions

For Software	
Convention	Description
<b>Bold font</b>	Used to identify software interface names e.g. <b>OK</b> , <b>Confirm</b> , <b>Cancel</b> .
>	Multi-level menus are separated by these brackets. For example, File > Create > Folder.
For Device	
Convention	Description
<>	Button or key names for devices. For example, press <OK>.
[]	Window names, menu items, data table, and field names are inside square brackets. For example, pop up the [New User] window.
/	Multi-level menus are separated by forwarding slashes. For example, [File/Create/Folder].

### Symbols

Convention	Description
	This represents a note that needs to pay more attention to.
	The general information which helps in performing the operations faster.
	The information which is significant.
	Care taken to avoid danger or mistakes.
	The statement or event that warns of something or that serves as a cautionary example.

## TABLE OF CONTENTS

<b>SAFETY WARNING .....</b>	<b>9</b>
<b>PRECAUTIONS .....</b>	<b>10</b>
<b>1 PANEL FEATURES .....</b>	<b>12</b>
<b>2 INSTALLATION.....</b>	<b>13</b>
<b>3 INTERFACE CONNECTION .....</b>	<b>14</b>
3.1 POWER INTERFACE .....	14
3.2 SIGNAL INPUT INTERFACE .....	14
3.2.1 USB INTERFACE .....	14
3.2.2 PUBLIC USB INTERFACE .....	15
3.2.3 TOUCH-USB INTERFACE.....	15
3.2.4 TYPE-C INTERFACE .....	16
3.2.5 HDMI-IN INTERFACE .....	16
3.2.6 VAG INTERFACE AND AUDIO-IN INTERFACE.....	17
3.2.7 DP INTERFACE.....	17
3.3 SIGNAL OUTPUT INTERFACE .....	17
3.3.1 HDMI-OUT INTERFACE .....	17
3.4 AUDIO INTERFACE .....	18
3.4.1 OPTICAL FIBER INTERFACE .....	18
3.4.2 MIC INTERFACE.....	18
3.4.3 AUDIO-OUT INTERFACE.....	18
3.5 INTERNET INTERFACE.....	19
3.5.1 LAN INTERFACE.....	19
3.6 CONTROL INTERFACE .....	19
3.6.1 RS232-IN INTERFACE .....	19
<b>4 PANEL DESCRIPTION .....</b>	<b>20</b>
<b>5 REMOTE CONTROL.....</b>	<b>21</b>
5.1 PRECAUTIONS FOR USE OF REMOTE CONTROL .....	21

- 5.2 BUTTONS ON REMOTE CONTROL..... 22
- 6 BASIC OPERATION ..... 23**
- 6.1 STARTUP/SHUTDOWN ..... 23
  - 6.1.1 STARTUP/SHUTDOWN ..... 23
  - 6.1.2 AUTO STANDBY ..... 23
  - 6.1.3 SAVE BEFORE SHUTDOWN ..... 24
  - 6.1.4 OPS ON/OFF (OPTIONAL) ..... 24
- 6.2 HOME PAGE ..... 24
- 6.3 SIDEBAR ..... 25
- 6.4 SIGNAL SOURCE ..... 26
  - 6.4.1 SOURCE PREVIEW ..... 26
  - 6.4.2 SOURCE SWITCHING ..... 26
  - 6.4.3 SOURCE SETTINGS ..... 27
- 6.5 HALF SCREEN MODE ..... 27
- 6.6 UTILITIES ..... 28
- 6.7 NETWORK SETTINGS ..... 29
  - 6.7.1 WIRELESS ..... 29
  - 6.7.2 ETHERNET ..... 29
  - 6.7.3 HOTSPOT ..... 30
  - 6.7.4 BLUETOOTH ..... 31
- 6.8 DEVICE MANAGEMENT ..... 32
  - 6.8.1 AUDIO INPUT ..... 32
  - 6.8.2 USB CAMERA ..... 32
  - 6.8.3 ACTIVE PEN ..... 33
  - 6.8.4 AI CAMERA ..... 33
- 6.9 WALLPAPER ..... 34
- 6.10 DATE AND TIME ..... 35
- 6.11 LANGUAGE ..... 35
- 6.12 POWER SETTINGS ..... 36



---

6.13	SECURITY .....	36
6.14	MORE SETTINGS.....	37
6.15	ABOUT .....	37
6.16	COMMENT .....	38
6.17	BACKGROUND PROCESS.....	38
6.18	ACTIVE PEN SETTING BAR.....	39
6.19	CAMERA.....	39
6.20	WHITEBOARD .....	40
6.21	SCREEN SHARE .....	43
6.22	FILES MANAGER.....	45
6.23	WELCOME PAGE.....	45
6.24	NFC .....	47
<b>7</b>	<b>TECHNICAL PARAMETERS .....</b>	<b>49</b>
7.1	VGA DISPLAY MODE.....	49
7.2	HDMI DISPLAY MODE.....	49
<b>8</b>	<b>ACCESSORIES .....</b>	<b>50</b>
<b>9</b>	<b>TROUBLESHOOTING .....</b>	<b>51</b>

## **Safety Warning**

1. Use only the power supply and voltage specified on the label.
2. A three-prong power cord is included. Make sure that the ground terminal of the wall outlet is well grounded before installation. Ensure to route the power cord away from passageways to avoid treading and keep it away from areas where it may get pressed.
3. Do not overload the power outlet and use a certified power outlet.
4. To prevent damage during thunderstorms, please disconnect the panel from the antenna and pull out the power plug as well as the network cable.
5. If the panel will not be in use for an extended period, it's recommended to switch it off and pull out the power plug.
6. In case of any abnormal sound or smell, please power it off immediately and pull out the power plug. If necessary, stop using it and contact the maintenance personnel as soon as possible.
7. Keep away from flammable and explosive materials (e.g., candle, electric stove, bulb).
8. Be careful to keep liquids and metal objects out of the panel. If so, stop using it immediately and contact the maintenance personnel.
9. If the panel is transferred from a low-temperature environment to a warmer one, there is a possibility that condensation may form inside it. In such case, the panel should be left idle for at least 24 hours before restarting to allow the condensate to air-dry.
10. Handle it with at least two persons, avoid impact and pay special attention to the display screen during the transfer.
11. To avoid injury, please install the base according to the instructions and then place the panel on an even and steady ground; or if the base is not installed, the panel should be firmly fixed to a wall according to the wall-mount bracket installation instructions.

12. Do not place the panel in any environment:
  - a) To direct sunlight, moisture, high/low temperature, or dust. To poor ventilation or an enclosed environment.
  - b) To where any flammable or explosive material is present.
  - c) To where any combustible or corrosive gas is present.
13. Do not expose the battery to excessive heat such as sunlight or fire, as there is a risk of explosion.

## **Precautions**

1. Do not disassemble the panel yourself in any way. Opening or removing the cover without permission may expose you to dangerous voltage or other hazards. If you have any maintenance problems, please contact a professional service person.
2. If the panel is dirty, first disconnect the power plug. Then dampen the cloth with water and wipe with the slightly wet cloth. Be careful not to apply too much pressure while cleaning the display screen, as this could result in scratches. Avoid using solvents like alcohol, gasoline, acid, alkali, detergent, volatile oil, and diluents since these solvents may damage the panel.
3. Condensate may form inside the screen under highly humid conditions, which is a normal phenomenon as temperature variations between the external and internal glass surfaces may lead to water droplets on the internal glass surface. Such water droplets will disappear automatically after 24 hours of normal use. Please rest assured to use the panel.
4. Do not insert any sharp objects or metal objects into the heat sink or touch the signal connector to avoid damage to the panel or electric shock due to a short circuit.
5. The main material of the LCD is glass, which is brittle. Do not apply pressure to the LCD to avoid damage.
6. To prevent the panel from falling over, avoid placing it on an unstable cell

phone, table or shelf. When placing the panel on a pushchair, take care while moving it to avoid sudden emergency stops, excessive force, or moving on uneven ground as this may cause the trolley and the panel to fall over.

7. The openings on the panel are designed for ventilation and heat dissipation to make sure the good performance. The ventholes should not be covered with objects such as newspapers, tablecloths, or curtains.
8. Do not allow the panel to display a static screen or an active screen for an extended period of time. This can cause a "ghosting" effect to appear on the screen, which may persist long after the power has been turned off.

## 1 Panel Features

The panel uses an HD LED-backlit LCD panel with infrared and multi-touch technology. It is equipped with interactive writing software to achieve the requirements of usability, interactivity, safe and environmental protection.

- **Mobile Interconnectivity (Optional)**

A mobile connected interactive environment can be presented by wirelessly connecting it to computers, PADs, and cellular devices, enabling wireless file transfer, wireless video pushing, and wireless screen projection.

- **Extraordinary Display**

The panel uses a high-quality, high-definition LCD panel, which displays the original color performance, soft frame, uniform display, no flicker, and fast response time, allowing a clear picture to be viewed from different angles.

- **Accurate Touch Control**

The panel incorporates advanced touch control technology with technical features such as fast response time, high positioning accuracy, strong environmental adaptability, and accurate operation. No special writing pen is required and operations can be performed directly with your hands by clicking and dragging instead of using the marker.

- **Highly Interactive**

The panel includes professional whiteboard writing software that offers a variety of pens, drawing tools, and other features that enable writing and movement on the screen to enhance interactivity.

## 2 Installation

1. At least two professional assists are required. Do not install the panel without permission to avoid injury from improper operation.
2. Make sure that you have professional assistance during installation to determine a mounting location that is strong enough to support the total weight of the panel and wall mount for a long time. Additionally, take steps to confirm that it is strong enough to withstand forceful use. Ensure that hanging points are directly on the wall and not on decorative molding or wallboard, which may not be strong enough.
3. Avoid installing the panel on a slanting surface or facing upward. Please install on a vertical wall to avoid dropping and causing injury.
4. To avoid damage of the panel or injury, keep the bracket out of the reach of children.
5. Tighten the screws during installation to avoid panel damage and injury.
6. The wall installation is shown in the figure below, ventilation space should be kept around the panel.

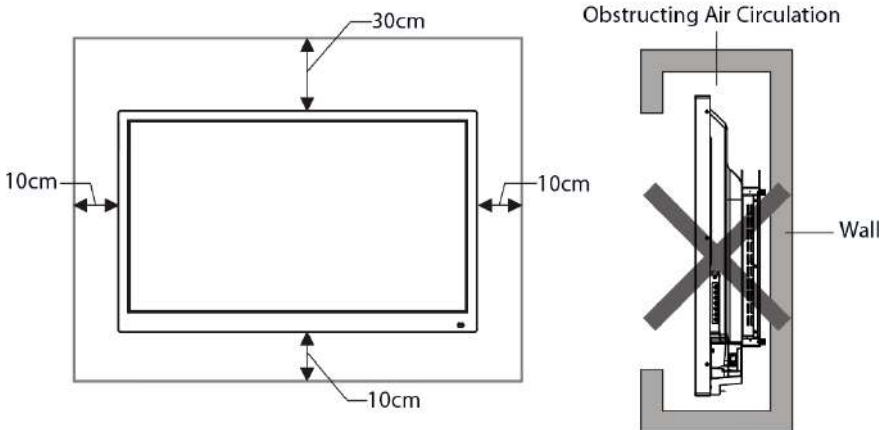

## 3 Interface Connection

**Note:** The interface connection instructions are provided below. The listed port types are for reference only, and do not cover all ports on this panel.

### 3.1 Power Interface



To power socket AC 100 to 240V, 50/60Hz.

### 3.2 Signal Input Interface

#### 3.2.1 USB Interface

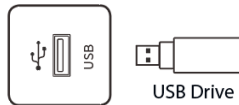

1. The interface is suitable for USB2.0/3.0. The output current of USB2.0 is 500mA, and the output current of USB3.0 is 900mA.
2. Media USB is compatible with the Android system of this panel and can be used to read data through the file manager of this panel.
3. If you're experiencing slow response or stuck operations while using a wireless keyboard and mouse, you can improve the reception range by replacing the wireless receiver with another USB interface or by using a USB extension cable to connect the wireless receiver.
4. Some non-standard USB drives may not be recognized; so, please use standard USB drives instead.
5. Recommend using USB 2.0 to upgrade software.

### 3.2.2 Public USB Interface

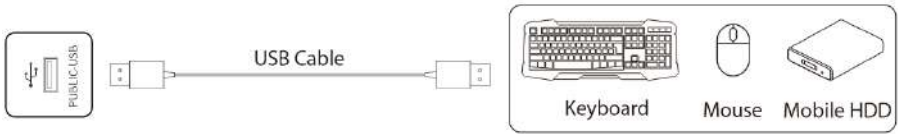

1. This interface is a USB3.0 interface, capable of connecting to USB drives and mobile hard disk drives for reading and writing data. It can also be used to connect a mouse and keyboard for input, and it can be used to provide power to an external USB device with a maximum current output of 900mA.
2. It can be automatically switched between Android and OPS system (The front TOUCH-USB cable should be connected to the external PC simultaneously).
3. Do not connect more than two devices (some mobile HDD) that need power supply.

### 3.2.3 TOUCH-USB Interface

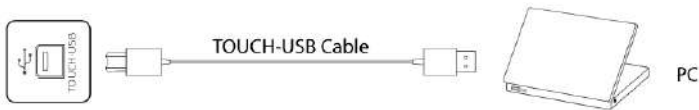

The TOUCH-USB interface is used together with the signal input interface. When both the TOUCH-USB interface and the signal source are connected to the same device, the external device can be operated on the panel through the touch function.



### 3.2.4 Type-C Interface

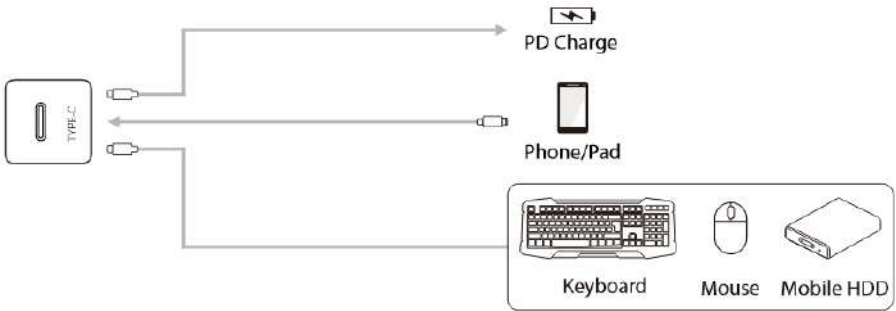

1. This interface supports only DFP mode; PD supports 15W Max resolution: 3840\*2160@60Hz.
2. The front Type-C interface supports PD charging (up to 20V and 3A with standard configuration), DP signal display (connected to the device display of TYPE-C output display such as mobile phones and tablets), and high-speed USB data transmission.

**Note:** In order to ensure stable and reliable use, please match certified standard wire.

### 3.2.5 HDMI-IN Interface

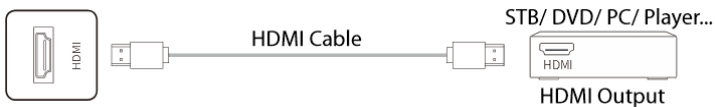

The maximum resolution of the HDMI interface is 4K@60Hz. For details about the signal format, see [7 Technical Parameters](#).

When the 4K@60Hz signal is played, the EDID version in the OSD menu need to be changed to EDID 2.0.

### 3.2.6 VAG Interface and AUDIO-IN Interface

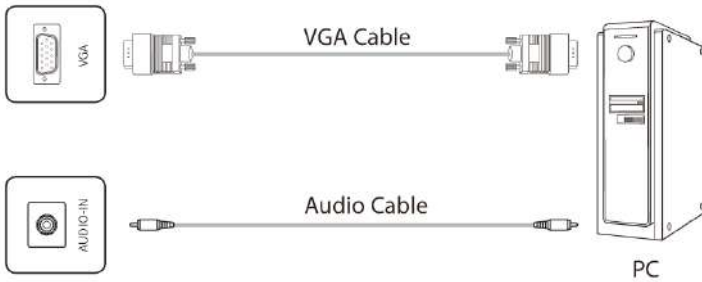

For details about signal formats supported by the VGA interface, see [7 Technical Parameters](#).

### 3.2.7 DP Interface

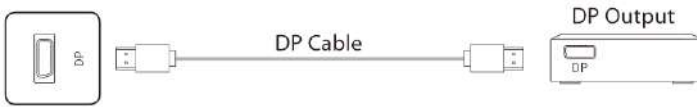

The DP interface can support a maximum resolution of 4K @ 60Hz. However, the quality of the signal may be affected by the length and quality of the DP cable being used. To ensure optimal performance, it is recommended to use a standard DP cable.

## 3.3 Signal Output Interface

### 3.3.1 HDMI-OUT Interface

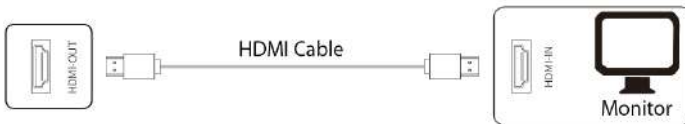

The HDMI-OUT interface can send the audio and video signals from one panel to the HDMI-IN interface of another panel. The second panel can then pass on the audio and video signals to the next panel, and so on.

The maximum number of connections is affected by the quality and length of HDMI cable, so it is recommended to use standard cable.

### 3.4 Audio Interface

#### 3.4.1 Optical Fiber Interface



The interface is capable of transmitting the audio signal from the panel to audio equipment with SPDIF-IN interface.

#### 3.4.2 MIC Interface



MIC interface can be connected to microphones.

#### 3.4.3 AUDIO-OUT Interface

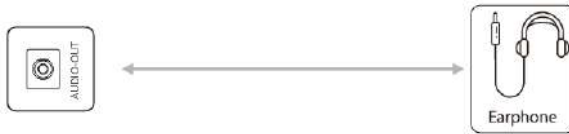

AUDIO-OUT interface can be linked to either earphones or an external speaker.

## 3.5 Internet Interface

### 3.5.1 LAN Interface



This interface is an onboard network interface. It is capable of connecting to the cable network on an Android device and supports automatic adaptation for 10M/100M/1000M. Only 10M/100M is supported for Android, and 10M/100M /1000M for OPS or another port for other devices.

After connecting either interface to the network, the OPS can share the priority network connection, and the other interface can connect to other devices to share the wired network through network cables. (Both interfaces must be set to automatically obtain IP addresses.)

## 3.6 Control Interface

### 3.6.1 RS232-IN Interface



After RS232-IN interface is connected to the computer, the panel can be operated through the computer.

## 4 Panel Description

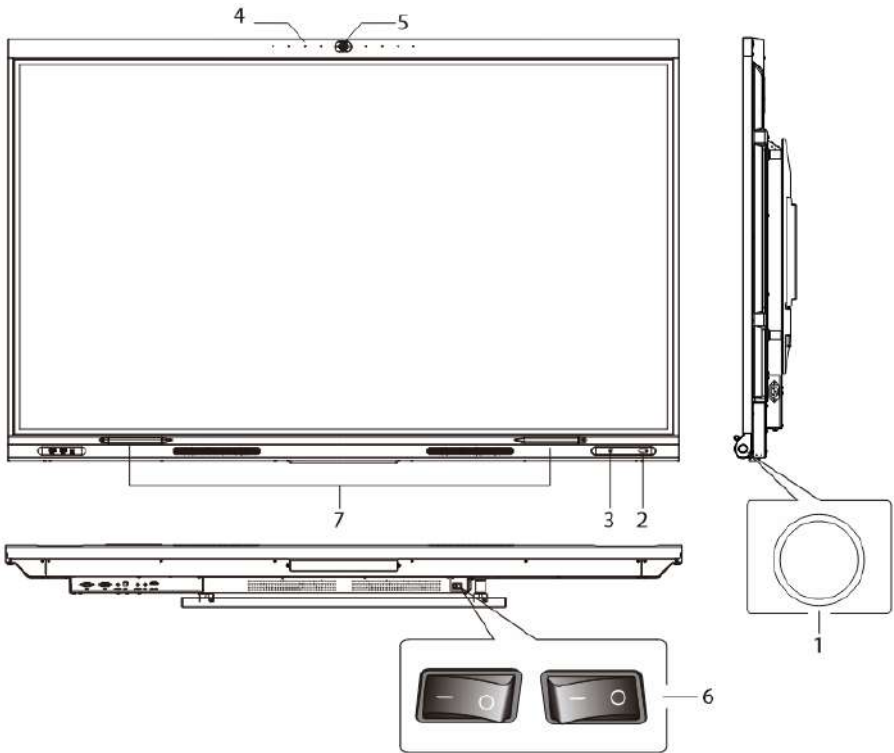

No.	Function
1	Power on or Standby. Short press to turn off backlight, long press to turn off.
2	Indicator light, remote receiver, and light sensing receiver.
3	NFC, users can set their own shortcut functions.
4	8-way array microphone pickup hole.
5	Built in camera.
6	On-off switch, "I" means ON, "O" means OFF.
7	Pen placement area. Pick up the pen and can quickly choose to enter the whiteboard or comment.

## **5 Remote Control**

### **5.1 Precautions for Use of Remote Control**

1. Aim the remote control at the remote receiver when using the remote control. Any object placed between the remote control and the remote receiver may disturb the operation.
2. Protect the remote control from vibration. Do not expose the remote control to direct sunlight as the heat may deform it.
3. When the remote receiver is subject to direct sunlight or strong light, the remote control may malfunction. In such case, please change the angle of the lighting or the panel or operate the remote control close to the remote receiver.
4. Replace the batteries in case of low battery as it will reduce the range of the remote control. If the remote control is to be left unused for a longer period of time or the batteries are being depleted then, please remove the batteries as battery leakage may damage the remote control.
5. Do not use batteries of different types or mix a new battery with a used one. Always replace batteries in pairs.
6. Do not throw batteries into a fire or recharge or disassemble batteries. Do not recharge, short-circuit, disassemble/assemble, heat or burn any used batteries. Please dispose of waste batteries according to applicable environmental regulations. Do not expose batteries to hot environment, such as direct sunlight or fire.

## 5.2 Buttons on Remote Control



No.	Button	Function
1	Power	Switch between power-on and standby states.
2	Source	Open or close the signal source list.
3	Cursor	Select or adjust the menu options.
4	Confirm	Confirm the operation.
5	Menu	Show or hide the main menu.
6	Home	Display the home page.
7	Return	Return to the previous interface.
8	OPS	Switch to OPS source.
9	Writing	Switch to the writing interface.
10	Snapshot	Take a screenshot.
11	Volume-	Decrease the volume.
12	Mute	Mute mode.
13	Volume+	Increase the volume.

### Note:

1. The picture is for reference only. Please refer to the physical appearance of the remote control.
2. The button function of the remote control may be different for different models. Please refer to the actual function.

## 6 Basic Operation

### 6.1 Startup/Shutdown

#### 6.1.1 Startup/Shutdown

Use a power supply ranging from 100V to 240V AC.

- **Physical Key**

The  buttons on the panel and remote control are unipolar switches. When the power is on, press this button to switch between the startup or standby state.

The  button on the backplane is a full-polarity switch. If the switch is turned to "O", then the power supply is turned OFF. If the switch is turned to "I", the power supply is turned ON.

- **On-screen**

Click the  icon in the lower left corner of the interface, click **Confirm** to turn off the OPS or the panel.



#### 6.1.2 Auto Standby

The panel will not enter standby mode, regardless of whether there is a signal input or not.

In the non-Android main interface, if there is no signal input within 15min, the panel will automatically enter the standby mode.



### 6.1.3 Save before Shutdown

Before shutting down, the panel saves picture and sound settings, which are restored upon powering on.

### 6.1.4 OPS ON/OFF (Optional)

If the panel is installed with the OPS module and is in the OPS signal source, the OPS module will start automatically. If not, it should be started manually.

Before turning off the panel, you should first use the touch function or mouse to turn off the OPS module from the Start menu. The **Standby** key on the panel or remote control can be used to turn off the panel only after the OPS module completely shut down. It is not allowed to press the **Standby** key or directly disconnect the power supply without turning off the OPS module, as it may damage the OPS module.

When the OPS module enters the OFF state and no operation is performed on the PC for a longer period of time, this panel will enter standby mode. To use the module, just restart the panel.





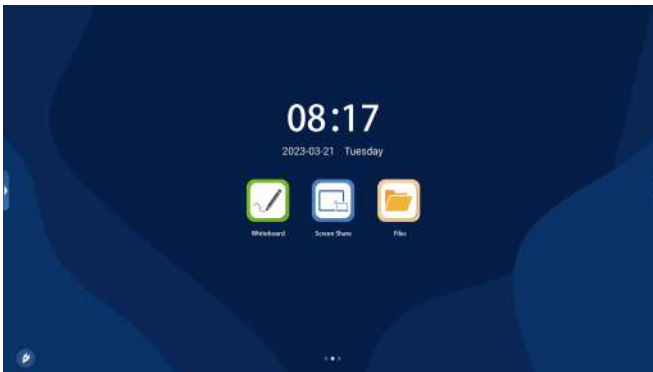



## 6.2 Home Page

Users can view time, date, USB drive information, network information, hotspot information and common software on the home page. Swipe right to view the welcome interface and swipe left to view all the applications.



## 6.3 Sidebar

To bring up the sidebar menu, click the sidebar shortcut arrow and swipe the edge of the screen inwards (or turn off the gesture switch).

Icon	Function	Description
	Return	Return.
	Home	Switch to the Android home page.
	Source	Source Settings, information source preview.
	Half Screen Mode	The whole screen moves down.
	Utilities	Back Counting, Eye Protection, Calculator, Vote, Screen Capture, Shot Stopwatch, Touch Lock, Spotlight, and Touch Sound.
	System	Network Settings, Device Management, Wallpaper, Date and Time, Language, Power Settings, Security, More Settings, and About.
	Comment	Open comment.
	Multi-task Manager	View and manage background running processes.
	Shutdown	Turn off the OPS or the panel.

## 6.4 Signal Source

### 6.4.1 Source Preview

To preview Android, VGA, OPS, HDMI1, HDMI2, TYPE-C, and DP sources, open the sidebar and click on the  icon to enter the **Signal Source** interface.

### 6.4.2 Source Switching

When switching the source, you can use the remote control or sidebar to switch. The method is as follows:

**Method 1:** Press the **Source** button of the remote control to enter the **Signal Source** interface. At this time, you can press the **Cursor** button of the remote control to select the source. Press the **OK** button of the remote control to switch the input source.

**Method 2:** Open the sidebar, click the  icon to enter the **Signal Source** interface, select a source and then click to switch.

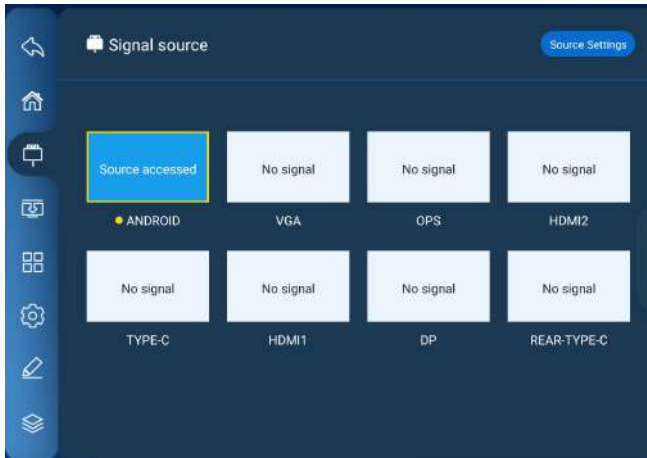

### 6.4.3 Source Settings

Open the sidebar, click on the  icon to enter the **Signal Source** interface, click **Source Settings** in the upper right corner to set the video quality, audio settings, auto select source on connection, auto select when no signal, rename source, source when power is on, source lock, no signal auto shutdown etc.

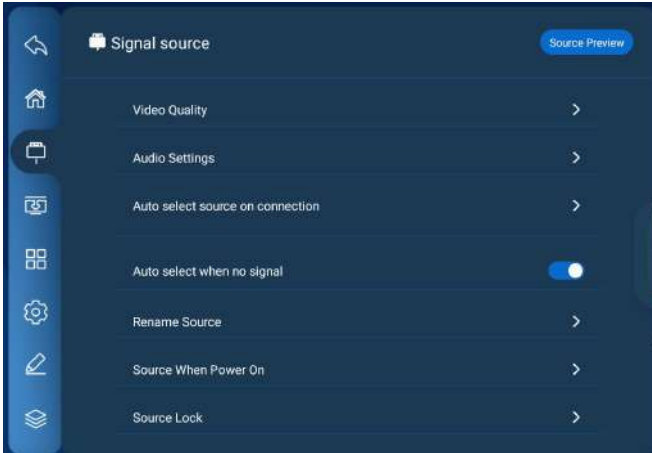

### 6.5 Half Screen Mode

Open the sidebar, click the  icon to move the screen down overall, and the click the **Up** button on both sides to exit.

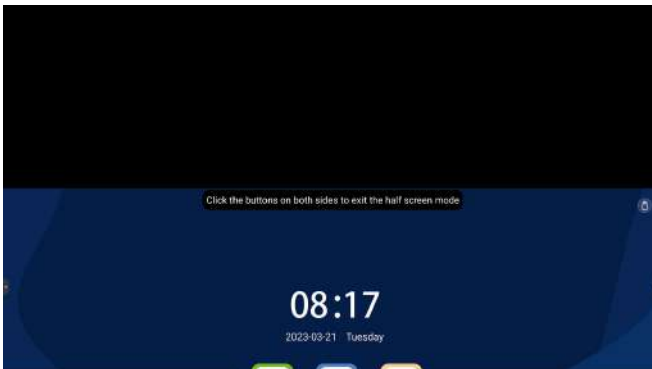

## 6.6 Utilities

Open the sidebar, click the  icon to enter the **Utilities** interface, users can use back counting, eye protection, calculator, vote, screenshot, screen recorder, shot stopwatch, touch lock, spotlight, touch sound and other tools. Users can also adjust sound and display brightness on this interface.

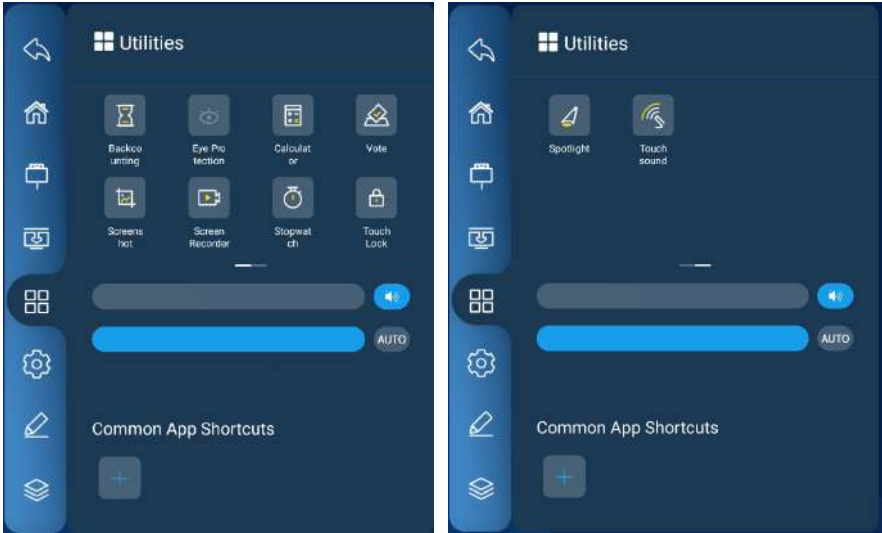

## 6.7 Network Settings

### 6.7.1 Wireless

Open the sidebar, click on the  icon to enter the **System Settings** interface, click **Network Settings > Wireless** to set wireless network.

1. Choose an available network and click, then input the password to connect.
2. If there is no desired network in the list, click **Add Network** to add a network manually.

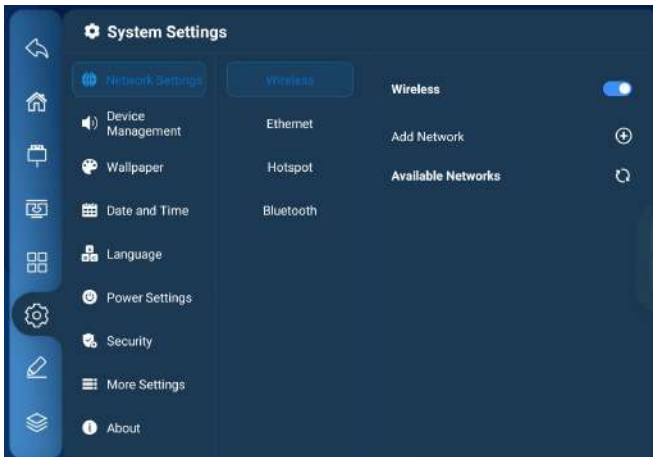

### 6.7.2 Ethernet

Open the sidebar, click the  icon to enter the **System Settings** interface, click **Network Settings > Ethernet** to set wired network.

1. Use a network cable to connect the panel and a router.
2. Enable the Ethernet to entering into the **Ethernet** interface.
3. Select **Auto**, and the panel will automatically obtain an IP address and connect to the network.
4. Select **STATIC**, and users need to manually enter the MAC address and IP address to connect it to the network.

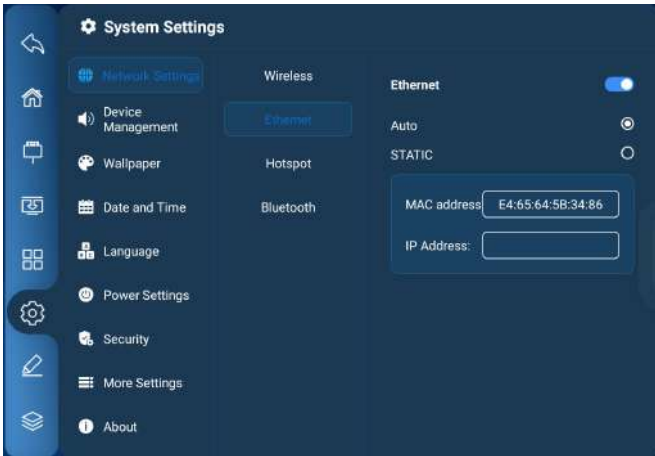

**Note:** This panel has two network interfaces, and both can be connected to the wired network (choose one of the two). If one network port is connected to a router and the other network port is connected to an external device, the Android operating system, the OPS (Windows only), and the external device form a LAN and can be connected to the network at the same time.

### 6.7.3 Hotspot

Open the sidebar, click the  icon to enter the **System Settings** interface, click **Network Settings > Hotspot** to set the hotspot.

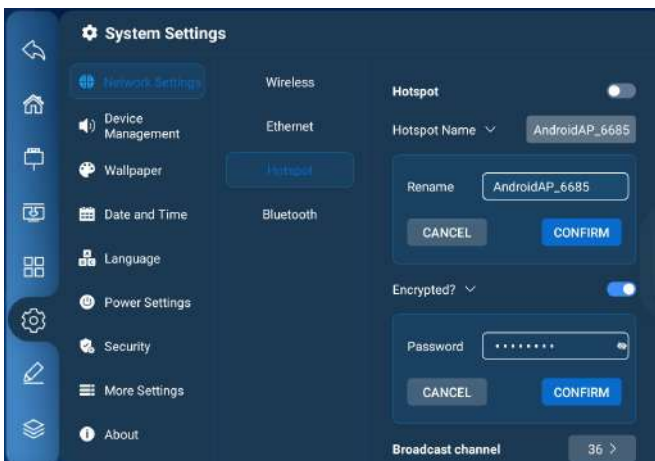

1. Turn on the **Hotspot** option. Enter the hotspot name in the textbox

(defaulted name is “AndroidAP-4520”).

2. Turn on the **Encrypted** option, the system will automatically generate a password, or you can enter your own password in the password box.
3. Click **CONFIRM** to save the settings, and then this network can be found by other wireless devices within the range.

### 6.7.4 Bluetooth

Open the sidebar, click the  icon to enter the **System Settings** interface, click **Network Settings > Bluetooth** to set Bluetooth.

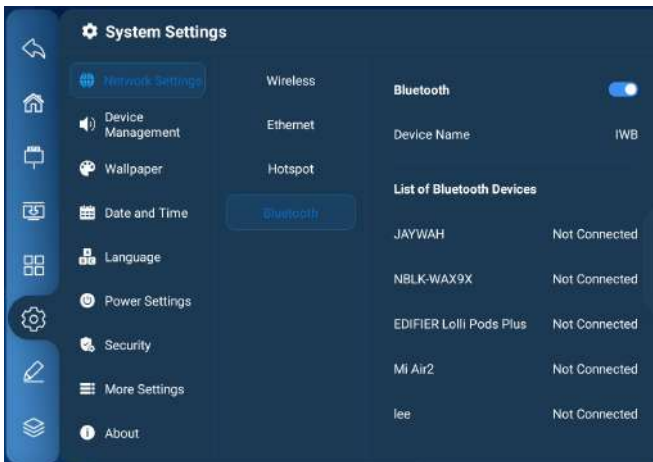

1. Turn on the **Bluetooth** switch.
2. Choose the Bluetooth device pair to connect.



## 6.8 Device Management

### 6.8.1 Audio Input

Open the sidebar, click the  icon to enter the **System Settings** interface, click **Device Management > Audio Input** to set audio input.

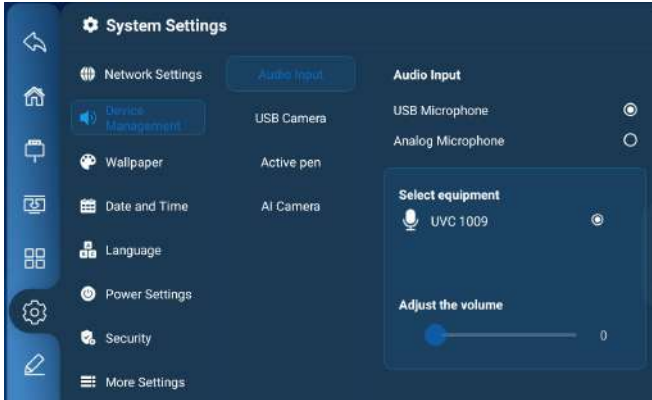

1. Connect the microphone to the panel.
2. Choose the microphone type, select the microphone in the **Audio Input** interface, and adjust the volume.

### 6.8.2 USB Camera

Open the sidebar, click the  icon to enter the **System Settings** interface, click **Device Management > USB Camera** to connect the camera.

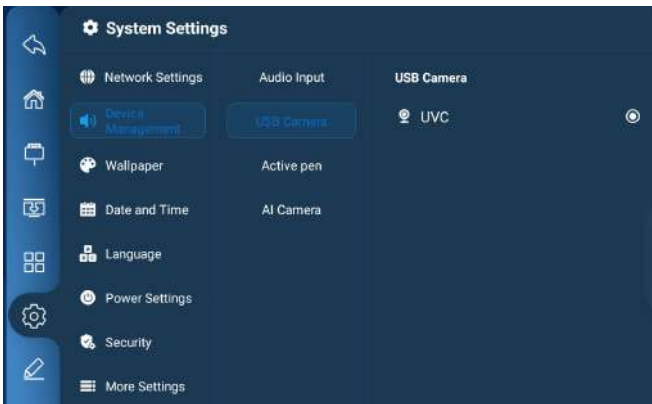

1. Connect the camera to the panel.
2. Select the camera in the **USB Camera** interface to connect.

### 6.8.3 Active Pen

Open the sidebar, click the  icon to enter the **System Settings** interface, click **Device Management > Active pen** to pair the active pen.

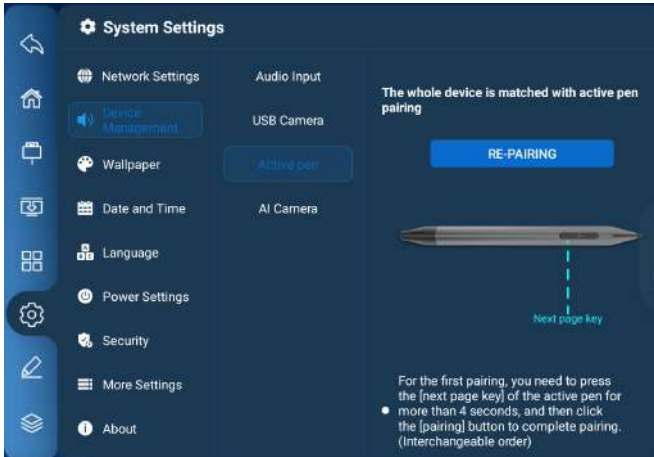

### 6.8.4 AI Camera

Open the sidebar, click the  icon to enter the **System Settings** interface, click **Device Management > AI Camera** to set the AI camera.

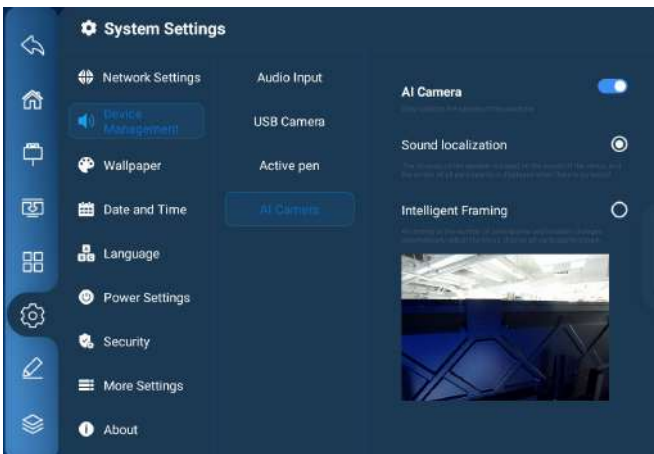

**Sound Localization:** The camera automatically tracks the speaker based on the sound source.

**Intelligent Framing:** The camera automatically adjusts the image based on the face.

## 6.9 Wallpaper

Open the sidebar, click the  icon to enter the **System Settings** interface, click **Wallpaper** to add the wallpaper and set wallpaper shuffling.

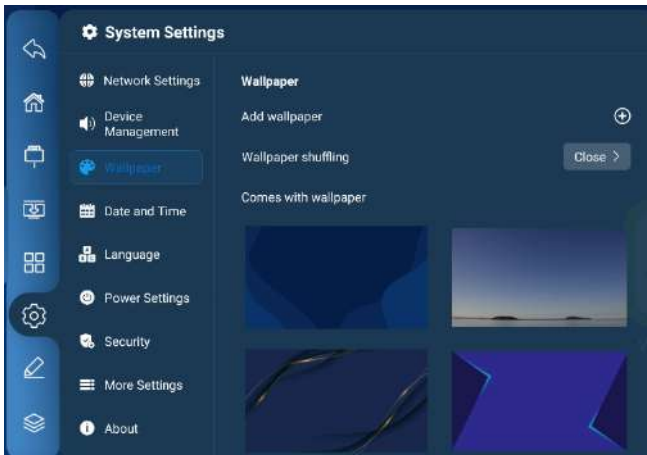

**Note:** The format of wallpaper and lock screen wallpaper should be PNG, and the resolution should be 1920\*1080 or 3840\*2160, but the file should not be too large, so as not to import and affect the smooth operation of the system.

## 6.10 Date and Time

Open the sidebar, click the  icon to enter the **System Settings** interface. Click **Date and Time** to set the date and time to automatically determine date and time, 24-hour format, time zone setting and date format.

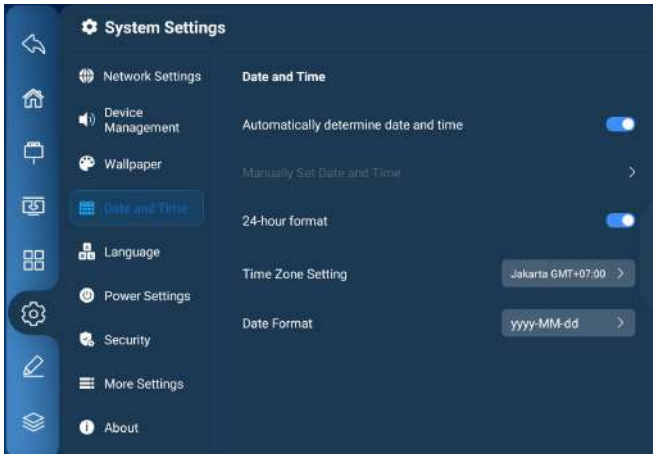

## 6.11 Language

Open the sidebar, click the  icon to enter the **System Settings** interface, click **Language** to set language and input method.



## 6.12 Power Settings

Open the sidebar, click the  icon to enter the **System Settings** interface. Click **Power Settings** to set the power-on mode, screen off and standby, timer for power on/off, and auto wake up.

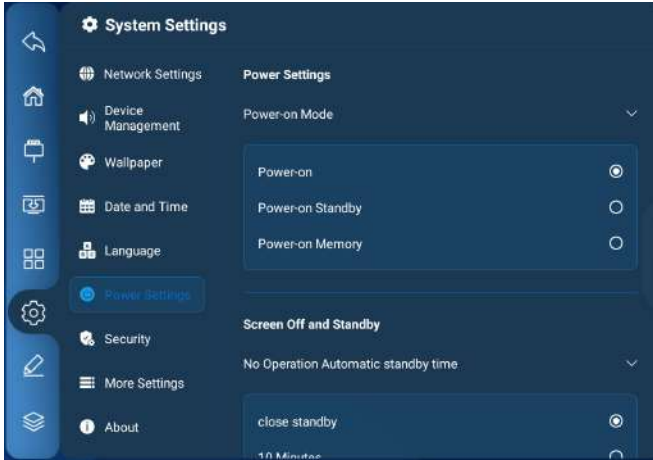

## 6.13 Security

Open the sidebar, click the  icon to enter the **System Settings** interface, click **Security** to set close password, pattern password, digital password, NFC password, and view certification.

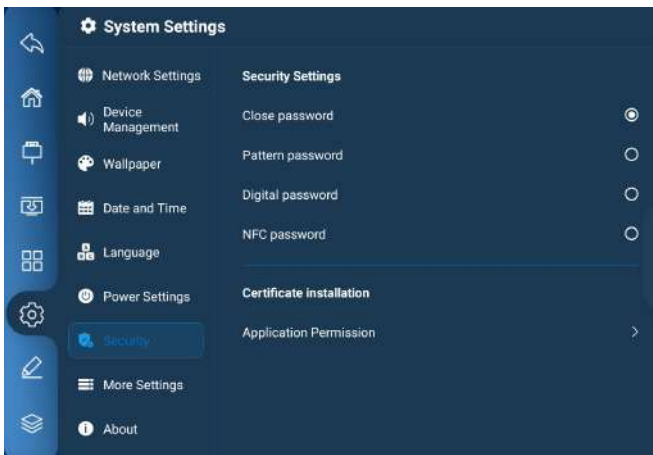

## 6.14 More Settings

Open the sidebar, click the  icon to enter the **System Settings** interface, click **More Settings** to set the smart lock and remote lock.

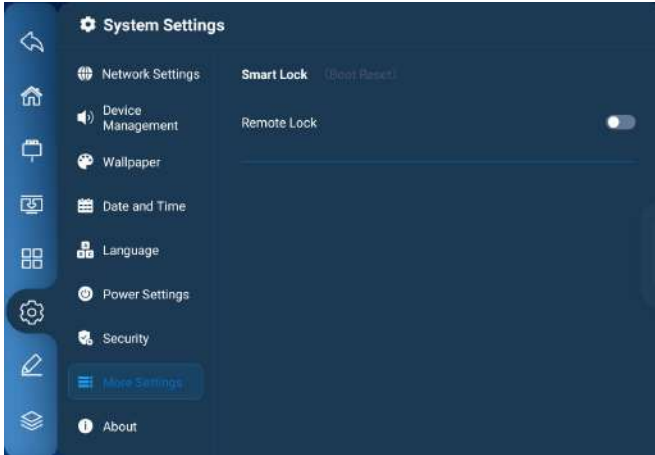

## 6.15 About

Open the sidebar, click the  icon to enter the **System Settings** interface, click **About** to view the relevant information about of the panel.

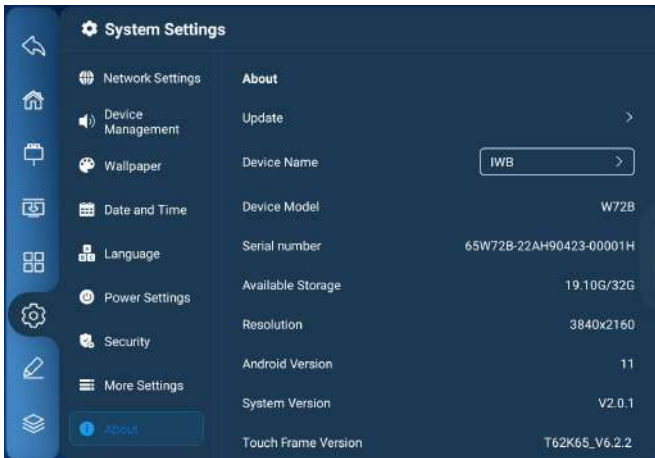

### 6.16 Comment

Open the sidebar, click the  icon to enter comment mode, users can use the pen to comment on the current screen.



### 6.17 Background Process



Open the sidebar, click the  icon to enter the **Background Process** interface to view and manage the background running processes.

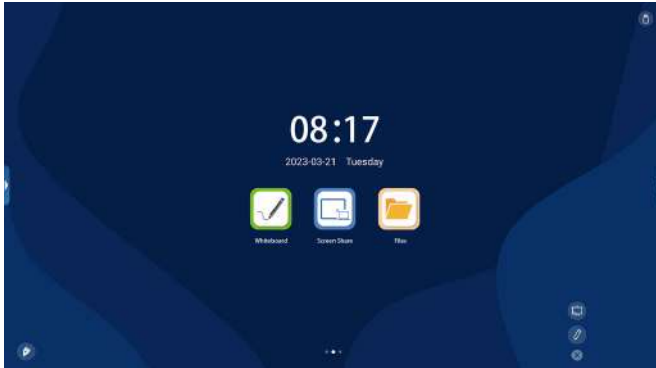

### 6.18 Active Pen Setting Bar

Take out the pen from the storage area, and the interface automatically pops up the function button.



Icon	Function	Description
	Whiteboard	Open the Whiteboard.
	Comment	Comment on the current screen.
	Close	Close the bar.

### 6.19 Camera

Click the **Camera** icon on the home page to enter the camera interface.

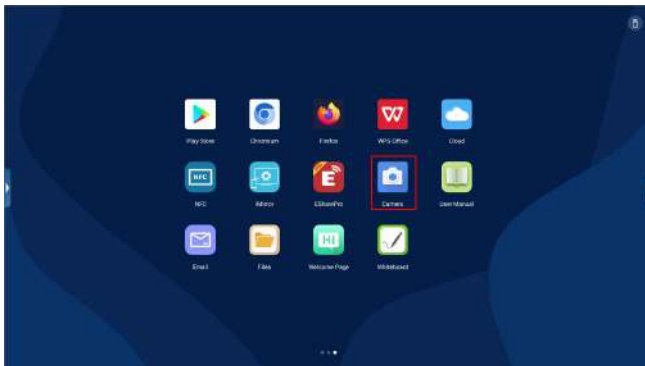



## 6.20 Whiteboard

Click the **Whiteboard** icon on the home page to enter the write interface.

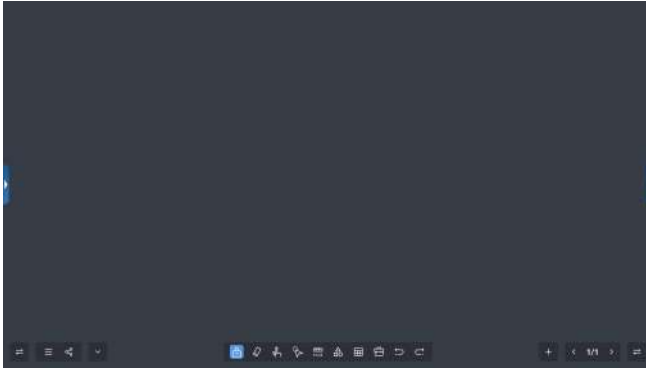

### Change:

Click  to change the sidebar on left or right side.

### Menu:

Click  to see the Menu, include brush, import notes, save file, background setting and quit.

### Share:

Click  to share the note via QR code or Email.

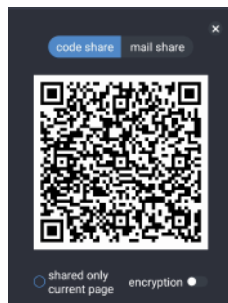

### Hide:

Click  to hide the sidebar.

**Pen:**

Click  to set the pen.

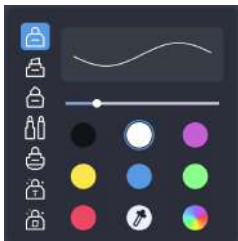
**Eraser:**

Click  to clean.

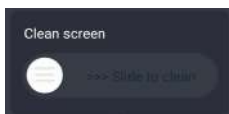
**Point:**

Click  to switch single point or Multi-point.

**Loop selection:**

Click  to create selection.

**Ruler:**

Click  to create a ruler.

**Figure:**

Click  to create a planer figure, a stereoscopic figure or a lattice template.

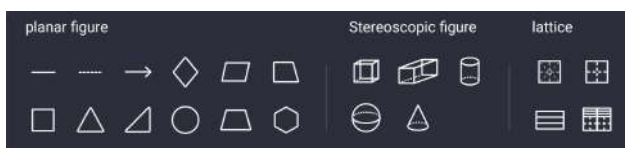
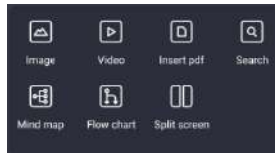



**Table:**

Click the  icon to create a table. The form automatically adjusts its width and height based on the input.

**Others:**

Click the  icon to insert image, insert video, insert PDF, search, add mind map, add flow chart or split screen.

**Revocation:**

Click  to return to previous step.



**Redo:**

Click  to redo the next step.

**Add:**

Click  to add a new page.

**Page:**

Click  or  to enter the previous page or next page.

**Preview:**

Click pagination  to preview all pages.

## 6.21 Screen Share

Users can share the phone or other devices' screen to the panel.

Take mobile phone as an example:

### 6.21.1 Wireless Share

1. Click the **EShare** icon or **Screen Share** icon on the home page to enter the share interface.
2. Scan the download QR code to download the **EShare** APP on the phone.

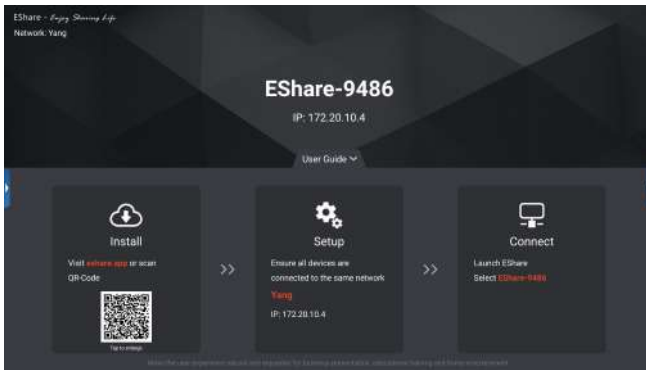

3. Open the **EShare** APP on the phone, and ensure the panel and phone are connected to the same network.
4. Select the panel on the phone.

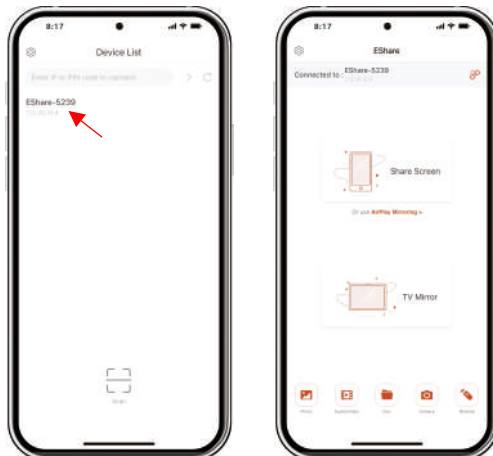

**Share Screen:** Share the phone screen to the panel.

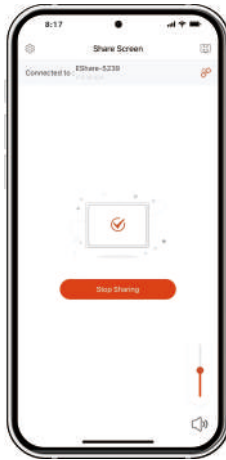

**TV Mirror:** Share the panel screen to the phone, and users can control the panel on the phone.



**If using IOS devices, users can mirror the screen directly.**

1. Click the **iMirror** icon on the home page to enter the share interface.



- Open the **Screen Mirror** on the phone, and ensure the panel and phone are connected to the same network.
- Select the panel on the phone, then the screen is shared to the panel.



### 6.21.2 Wired Share

Users can use HDMI cable or Type-c cable (full function cable that can charge, transmit data and mirror screen) to connect other signal input devices, please refer to [3.2.5 HDMI-IN Interface](#) and [3.2.4 Type-C Interface](#).

### 6.22 Welcome Page

On the home page, slide right to enter the welcome page.

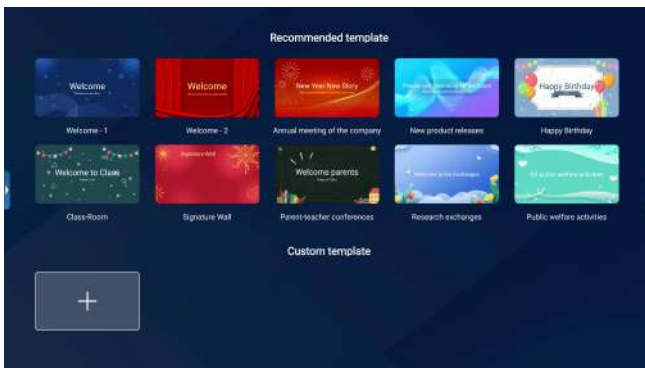



1. Choose a template or click + button to input a new image.
2. Edit the template and click **START SHOWING** to show the welcome page.

**Edit Button Description:**

Edit Button		Function	
Save	Save the template.		
Template	Quick switching template.		
Text	Quick switching text composition.		
Music	Insert music.		
Insert text	Insert a new text.		Enlarge the font size.
			Reduce the size.
			Bold font.
			Change font color.
Reset	Restore initial settings.		

## 6.23 Files Manager

Click the **Files** icon on the home page to enter the **Files Manager** interface. The manager supports the playing of images, videos, audio, etc. Long pressing can move, copy, and delete selected files.

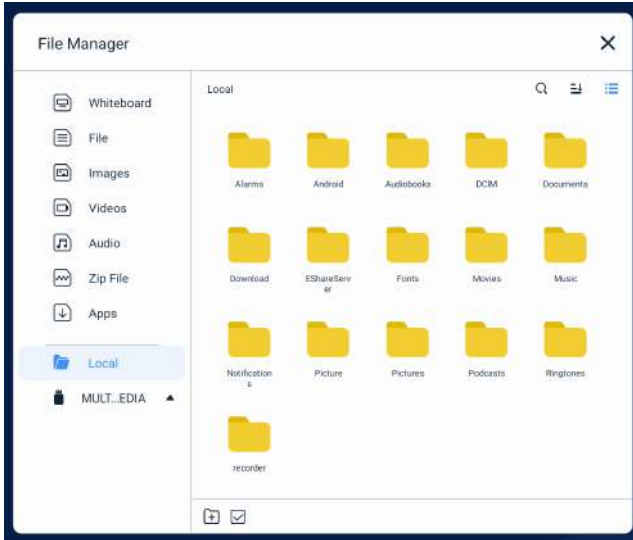

## 6.24 NFC

- **Shortcut APP**

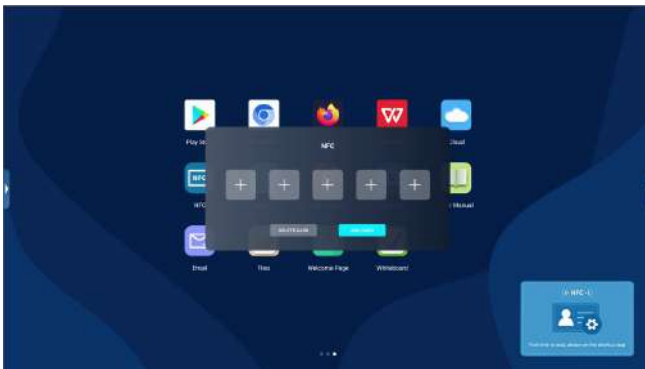

1. Click the **NFC** icon on the home page to enter into the NFC interface.
2. Click **ADD Card** to add a new NFC card.



3. Place the NFC card in the NFC sensing area.
  4. After the recognition is successful, click on the lower right corner to select a shortcut APP, which include Whiteboard, Browser, OPS, File and so on.
  5. After the setting is successful, swipe the card to open the corresponding APP directly.
- **NFC Password**
    1. Open the sidebar, click the  icon to enter the **System Settings** interface, click the **NFC password**.
    2. Place the NFC card in the NFC sensing area.
    3. After the recognition is successful, users can swipe the NFC card to unlock the panel.



## 7 Technical Parameters

### 7.1 VGA Display Mode

No.	Mode	Resolution	Refresh Rate
1	VGA	640*480	60Hz
2	SVGA	800*600	60Hz
3	XGA	1024*768	60Hz
4	WXGA	1360*768	60Hz
5	WUXGA	1920*1080	60Hz

### 7.2 HDMI Display Mode

No.	Mode	Resolution	Refresh Rate
1	SD	720*480	70Hz
2		720*576	50Hz
3		1280*720	50Hz
4		1280*720	60Hz
5	HD	1920*1080	50Hz
6		1920*1080	60Hz
7	UD	3840*2160	30Hz
8		3840*2160	60Hz

## 8 Accessories

Name	Quantity
Remote Controller	1pc
Wall Bracket	1pc
Power Cable	1pc
USB A-B Cable	1pc
HDMI Cable	1pc
Stylus	2pcs
Eraser	1pcs

**Note:** Some models are not equipped with USB A-B cable and HDMI cable as standard. Please refer to the actual configuration.

## 9 Troubleshooting

**Note:** Before preparing to make repairs, please check the following table to see if you can find the cause of the problem you are experiencing. If the issue cannot be resolved according to the instructions, please contact the panel service center for further assistance with panel maintenance.

### 1. **The screen does not display anything, there is no sound, and the indicator light does not work.**

**Possible Cause:**

Looseness of the power plug, and power connection failure.

**Solution:**

Check if the power cord is properly connected.

### 2. **Pictures shown on the panel have dotted line or stripe interference**

**Possible Cause:**

Signal interference caused by automobile, neon light, electric hairdryer, etc.

**Solution:**

Try to find out the panels that affect your panel and then remove them from the vicinity of your panel. Alternatively, you can insert the power plug into another socket.

### 3. **Pictures shown on the PC are offset, and do not cover the entire screen, go beyond the screen, or are blurred**

**Possible Cause:**

- a) Improper adjustment.
- b) Wrong display mode.

**Solution:**

- a) Use the auto adjustment function.
- b) Enter "PC Screen Adjustment" to adjust the horizontal or vertical position.

- c) Use the recommended mode.

#### **4. Short remote-control distance, malfunction of remote control.**

##### **Possible Cause:**

- a) The remote receiver of the panel is being blocked by some other object.
- b) Battery level of the remote control is low.

##### **Solution:**

- a) Move the object to avoid blocking the remote receiver.
- b) Replace the battery.

#### **5. The panel gets stuck, crashes or cannot be operated.**

##### **Possible Cause:**

- a) Too many programs are running.
- b) Normal operation of the panel is disturbed by external environment (e.g., lightning, static electricity).

##### **Solution:**

Disconnect the panel from power supply, wait for 1-2min and reconnect power supply, then restart the panel.

#### **6. The touch is slow, it doesn't work.**

##### **Possible Cause:**

Too many programs are running.

##### **Solution:**

To resolve issues caused by a program that consumes a large amount of memory, you can try to clean up the program or restart the panel.

#### **7. OPS can't be turned on so, no display, no touch.**

##### **Possible Cause:**

OPS has not been fixed well.

**Solution:**

Reinstall the OPS computer.

**8. Touch excursion.****Possible Cause:**

Caused by the computer's coordinate system, need to do some correction.

**Solution:**

Enter the control panel to select the correction processing.

**9. Invalid touch of the external computer.****Possible Cause:**

- a) The signal source is inconsistent with the corresponding interface of the touch USB cable.
- b) The touch USB cable is way too long or of low quality.

**Solution:**

- a) Check and change the corresponding interface of the touch USB cable.
- b) Change another shorter or better-quality touch USB cable.

ZKTeco Industrial Park, No. 32, Industrial Road,  
Tangxia Town, Dongguan, China.

Phone : +86 769 - 82109991

Fax : +86 755 - 89602394

[www.zkteco.com](http://www.zkteco.com)



Copyright © 2023 ZKTECO CO., LTD. All Rights Reserved.