

# Installation Instruction

AL10DB&AL20DB

Version: 1.1

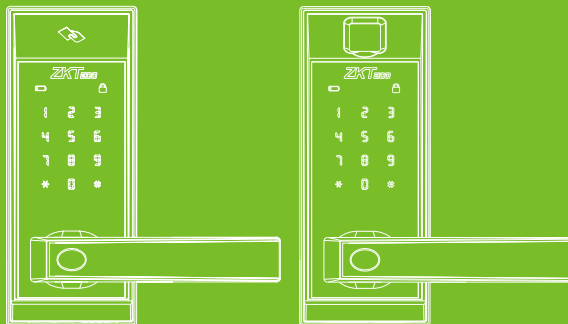

# Single Latch(Illustrated by the case of AL20B)

## Installation Diagram

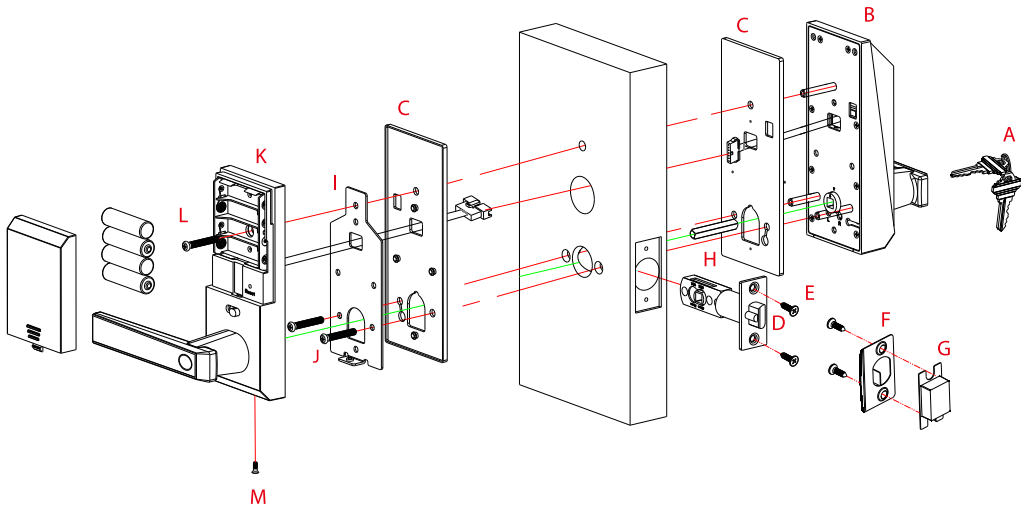

# Packing List

B

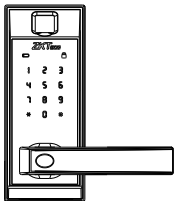

K

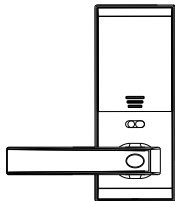

C

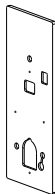

I

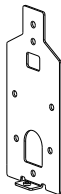

F



G

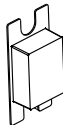

D

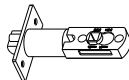

N



A



H(1pcs)



M (2pcs)



E(4pcs)





J(2pcs)

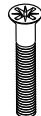

L(1pcs)



Door thickness	30-38mm	39-46mm	47-54mm
	7.5*7.5*56	7.5*7.5*64	7.5*7.5*72
	PM4*20	PM4*30	PM4*40
	KM4*25	KM4*35	KM4*45
	KM3*5		

**Note:** To ensure proper functioning of the device only use the mounting hardware package for your door thickness.

# Door Preparation

1. Check the door thickness and prepare the corresponding mounting hardware package.

Door Thickness (mm)	H Spindle Length (mm)	J Screw Length (mm)	M Screw Length (mm)	L Screw Length (mm)
30~38	56	20	10	25
39~46	64	30	10	30
47~54	72	40	10	40

2. Check door opening direction.

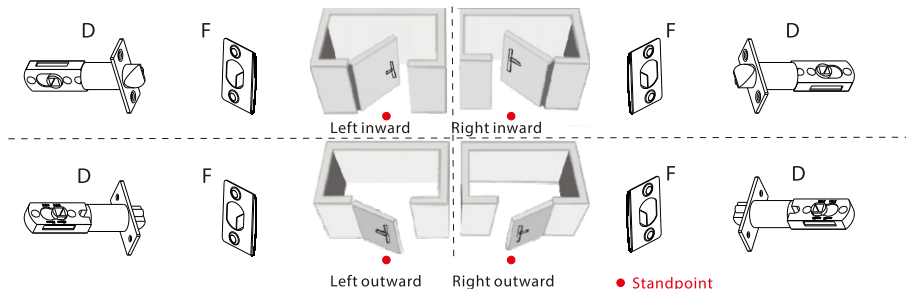

**Note:** Please refer to the above picture to adjust the direction of strike plate F and latch D.

# Installation

## 1. Drill holes on the door.

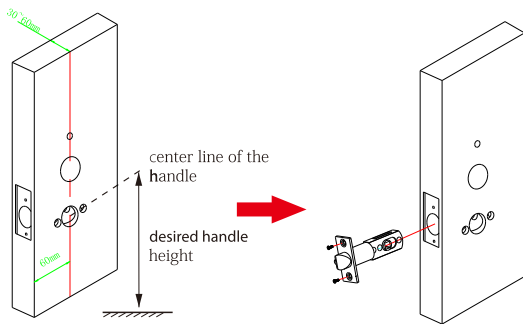

- 1) Align the template along the vertical center line of the latch(D) at the desired handle height, and tape it to the door.
- 2) Mark the holes first, and then start drilling.

## 2. Install the latch (D).

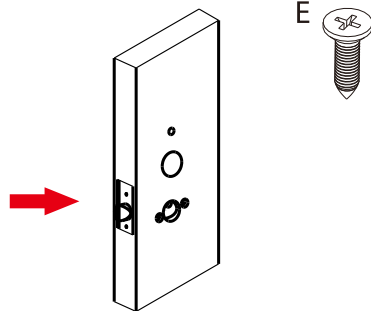

**Note:** Installing the mortise(D) on the door by inserting screws(E).

### 3. Install outdoor unit (B) with gasket (C) and spindle (H) on the door.

3.1 Put gasket(C) on outdoor unit(B).

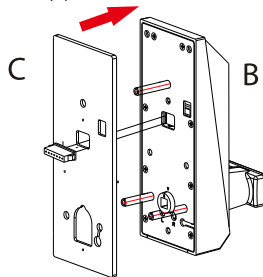

3.2 Insert spindle(H) into the clutch.

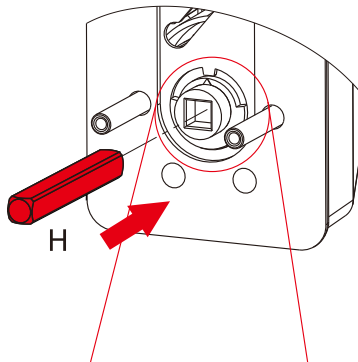

3.3 Attach outdoor unit(B) to door by putting it through door holes.

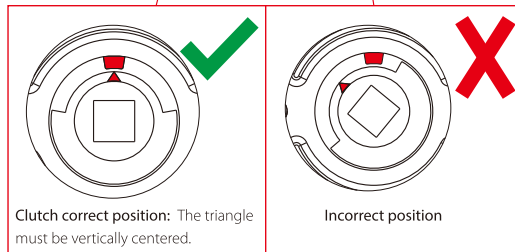
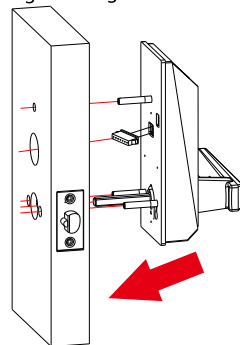

#### 4. Install mounting plate (I) with gasket (C) on the door.

4.1 Put mounting plate(I) on gasket(C).

4.2 Inserting screws(J) to secure the outdoor unit.

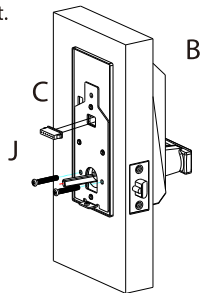
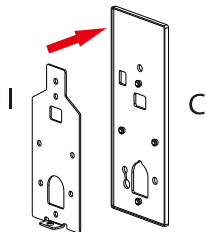

#### 5. Install indoor unit (K).

5.1 Connect the indoor unit(K) cable to the outdoor unit(B).

5.2 Push the cable into the hole.

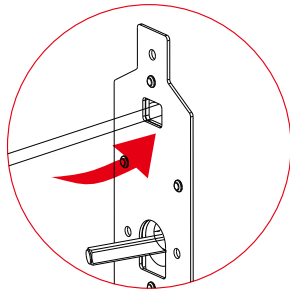
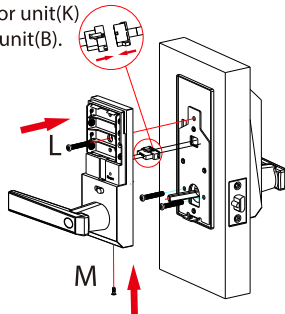
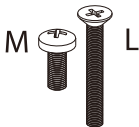

5.3 Secure indoor unit(K) to outdoor unit (B) by inserting screws(M) and screw(L).



## 6. Insert batteries.

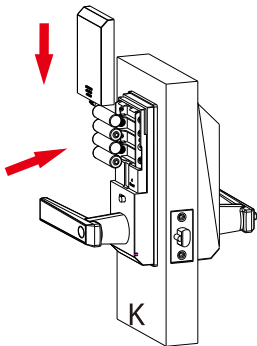

## 7. Mark and drill holes for the strike.

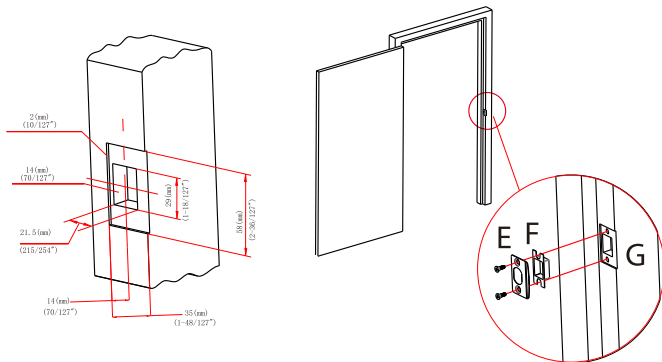

## 8. Test the lock by rotating the back handle and using the mechanical Key (A).

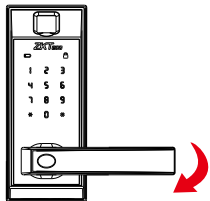

### Note:

- 1) When the door is locked and the clutch is idle, the front handle can be turned, but the door will remain locked.
- 2) When you are inside the door, turn the handle upward to lock the deadbolt for more security. When you go out, verify your fingerprint first, and then turn the handle up to lock the door for the safety of your property.

## Change latch (D) direction.

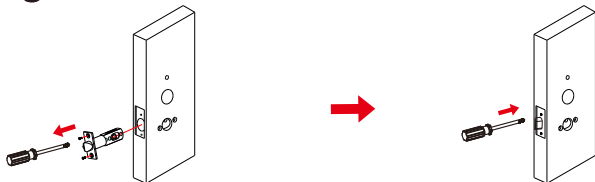

Remove screws from the latch trim panel with a screwdriver and rotate the latch bolt at 180°.

Fix the latch trim panel by using screws.

## How To Use Key & Changing Handle Direction?



1. Use wrench (N) to remove screw.

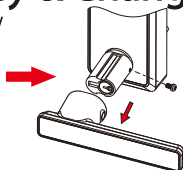

2. Pull handle away from lock.

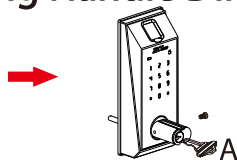

3. Insert mechanical key into hole to open the door.

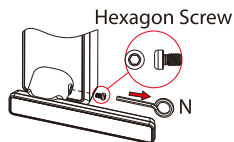

1. Use wrench (N) to remove screw.

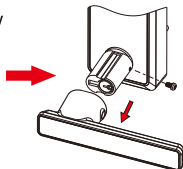

2. Pull handle away from lock.

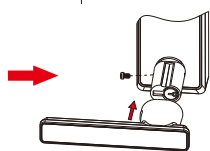

3. Change handle direction and replace.

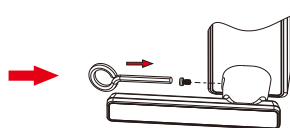

4. Replace the screw on the opposite side.

# Remarks

1. The default setting of the device allows ANY fingerprint to unlock.
2. Please register at least one administrator for the newly installed lock. Without administrator, no registration for any normal user is allowed.
3. The lock is equipped with mechanical keys for manually unlocking. Please keep the mechanical keys in a safe place.
4. To power on the lock, four alkaline AA batteries (not included) are required. Non-alkaline and rechargeable batteries ARE NOT RECOMMENDED.
5. Do not remove batteries when the lock is in working state.
6. Please replace the battery soon when the lock prompts the voice of low battery.
7. If there is no activity performed on the lock for 10 seconds the fingerprint sensor will go to sleep.
8. For best results, apply clean fingers to the fingerprint sensor.

ZK Building, Wuhe Road, Gangtou, Bantian, Buji Town,  
Longgang District, Shenzhen China 518129  
Tel: +86 755-89602345  
Fax: +86 755-89602394  
[www.zkteco.com](http://www.zkteco.com)

