

QUICK START GUIDE

Applicable model: 2.8 inches Color Screen Facial
Recognition Series Products

Device Overview

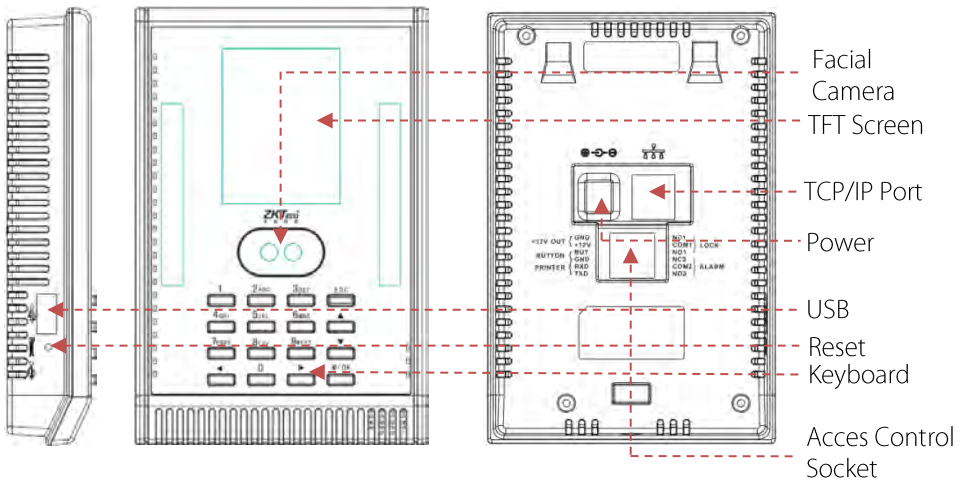
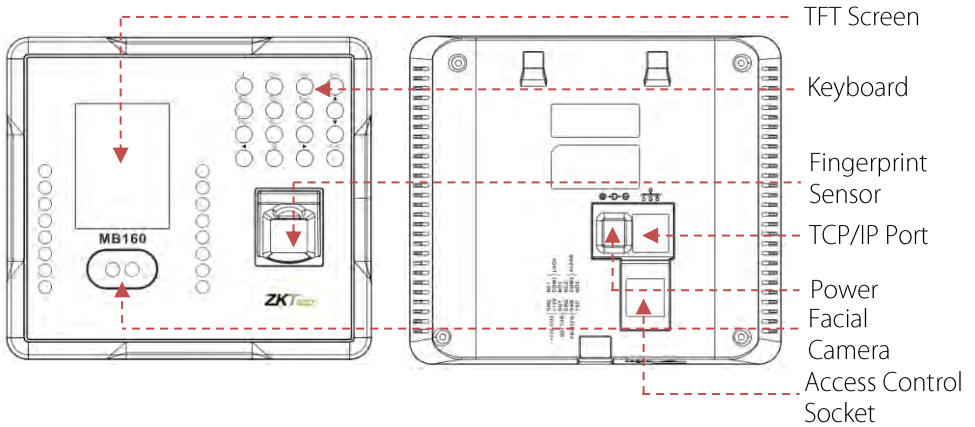

Device Overview

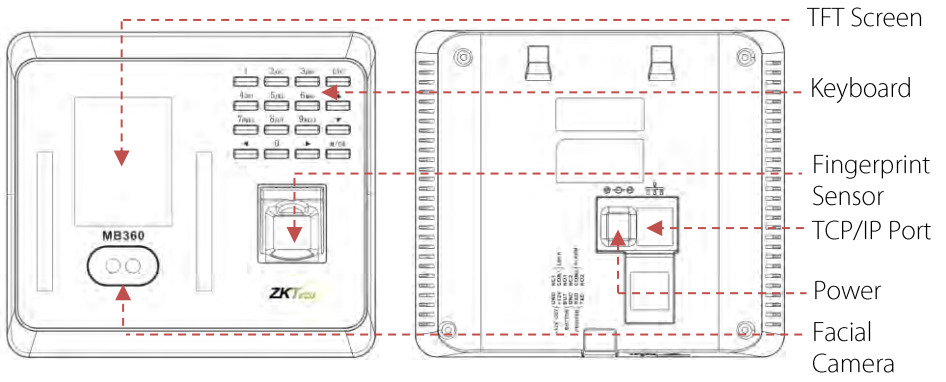

Installation

1. Installation environment

a. Recommended location

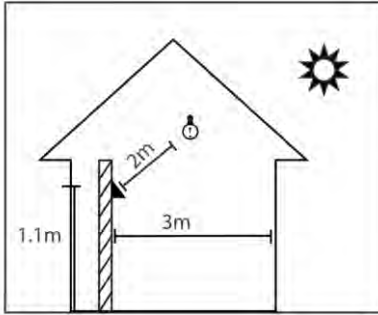

Install the device indoors at least 10 feet (3m) away from window, and 6.5 feet (2m) from light source.

It is not recommended to install on the windows or in outdoor.

b. Not recommended locations

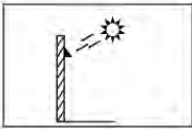

Direct Sunlight
Outdoor

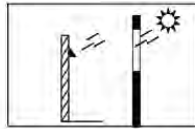

Direct Sunlight
through window

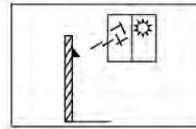

Indirect Sunlight
through window

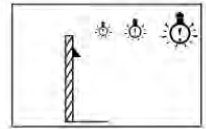

Too close to
light source

2. Installation step

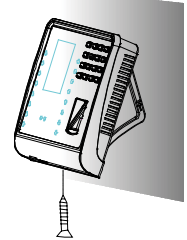
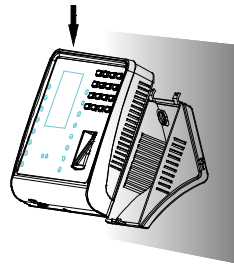
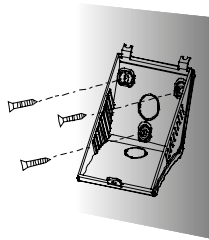
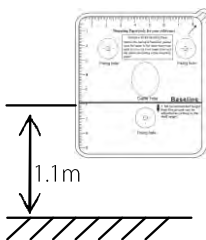

- Stick the mounting paper and drill holes accordingly.

Note: The distance from the baseline to the ground should be 1.1m for a height range of 1.55m-1.85m. And if the distance is 1.2m, then the height should be more than 1.65m.

- Fix the plate with the screws on the wall through the drilled holes.
- Then fix the device into the plate.
- Lastly, fix the device through screw at the bottom.

Wiring Diagrams

1. Ethernet Connection

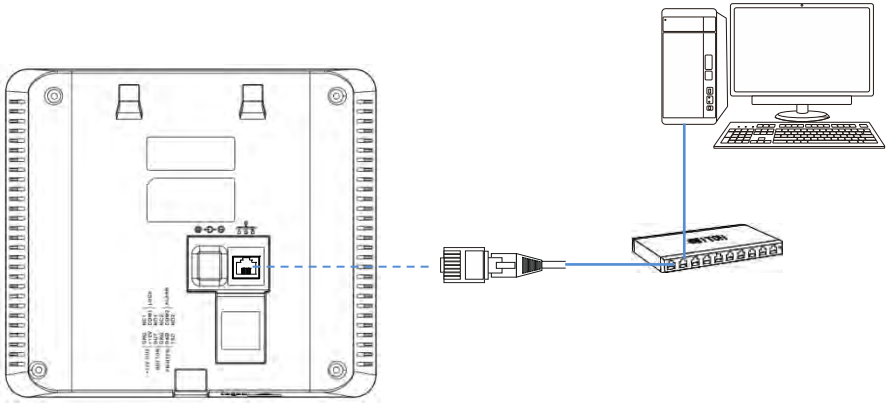

2. Device sharing power to lock

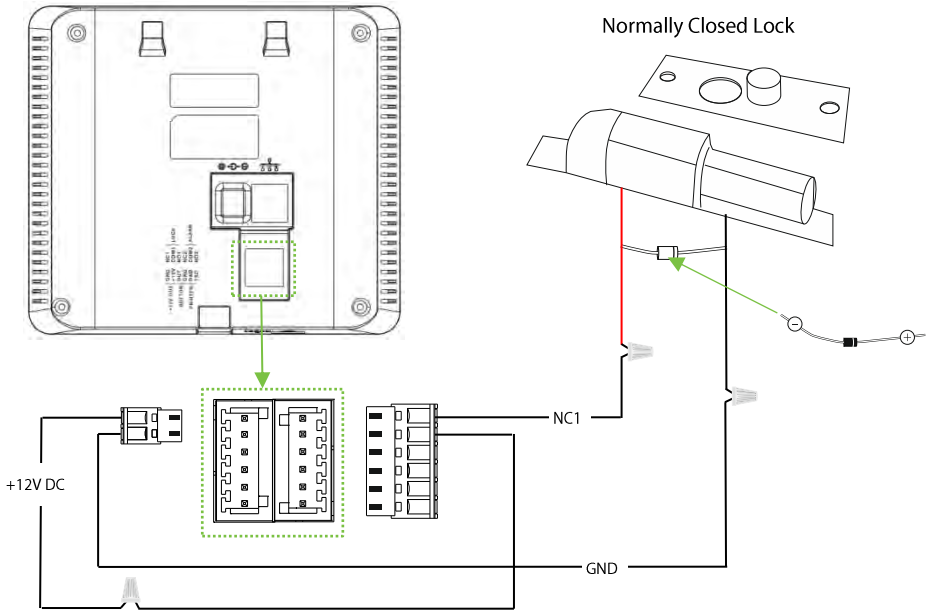

Wiring Diagrams

3. Exit Button Connection

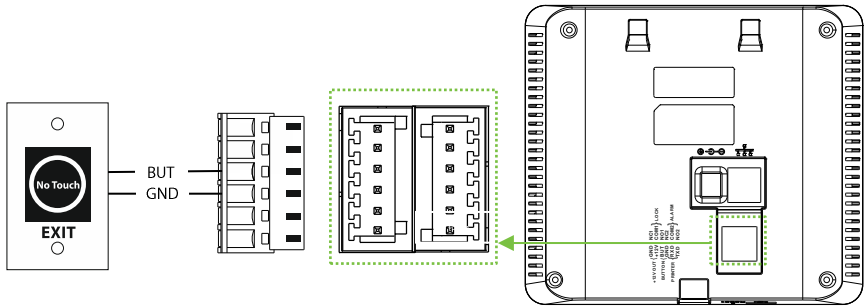

4. Printer Connection

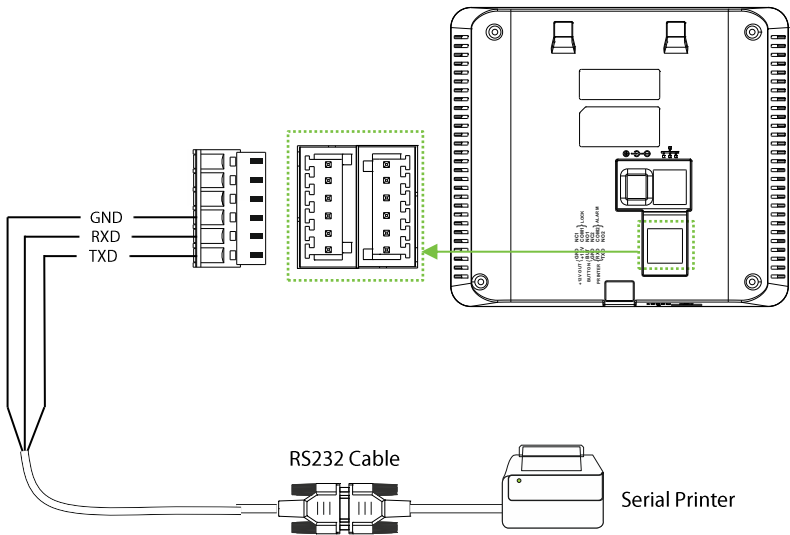

Wiring Diagrams

5. Alarm Connection

- External Alarm Normally Opened connection

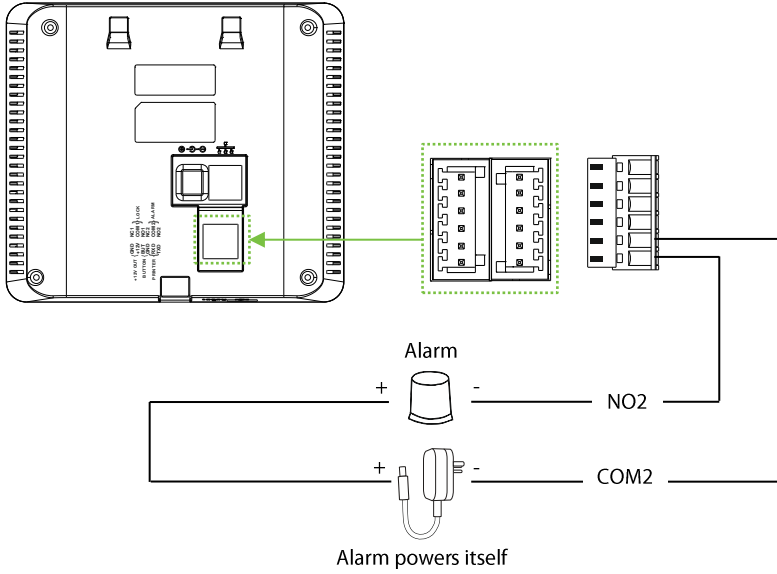

Facial expressions and Gestures

1. Recommended standing positions

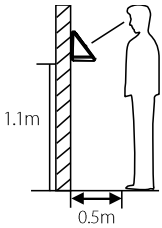

The distance between the user and the device should be 0.5m for a height range of 1.55m-1.85m. It can be adjusted

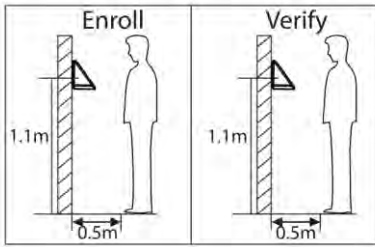

The distance between the user and the device should be same while enrolling and verifying. And also the distance between the device and the ground must be same while enrolling and verifying.

2. Not recommended positions

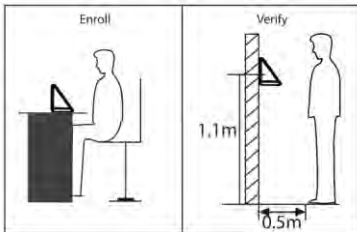

Non-identical posture

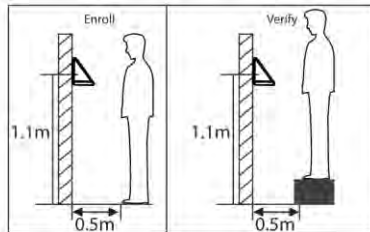

Non-identical height

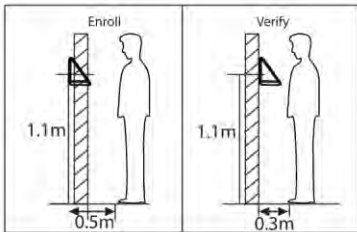

Non-identical distance

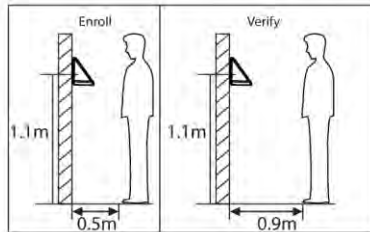

Non-identical distance

Note: Please keep natural posture and expression while enrolling and verifying.

Facial expressions and Gestures

3. Recommended facial expressions

- Please adjust your eyes into the green box by moving forward or backward while enrolling.

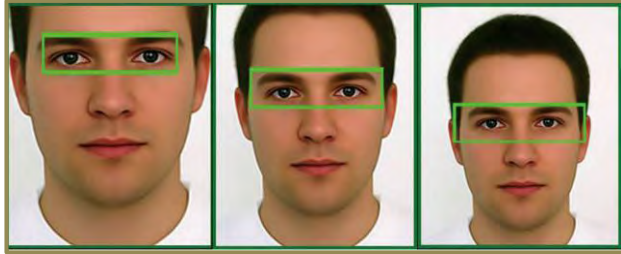

- Please adjust your face in the green box to make it at the center of the screen.



4. Not recommended facial expressions and gestures

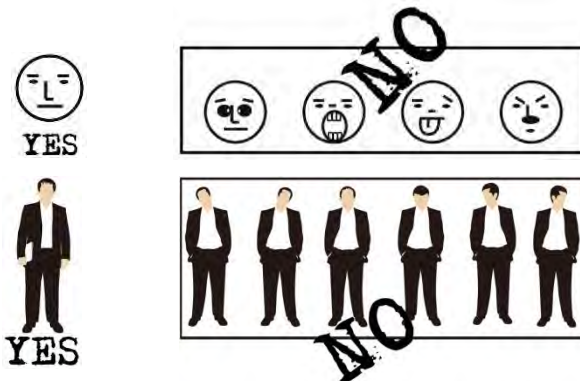

System interfaces

1. Enrolling New User

Go to Main Menu→User Mgt→New User

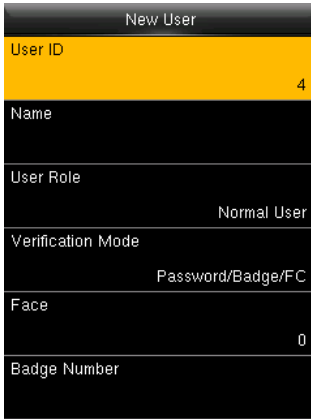

New User	
User ID	4
Name	
User Role	Normal User
Verification Mode	Password/Badge/FC
Face	0
Badge Number	

User ID: Enroll user ID; it supports 1-9 digits of numbers.
Use Role: Select the user role between Normal User and Super Admin.
Verification Mode: Select required mode from list.
Fingerprint★: Enroll a fingerprint or fingerprints.
Face: Enroll face according to the prompts of screen and voice.
Badge Number★: Enroll a badge by swiping the badge
Password: Enroll the password; it supports 1-9 digits of numbers.

★ NOT ALL THE DEVICES HAS THIS FEATURE.

2. Access Control

Go to Main Menu→Access Control

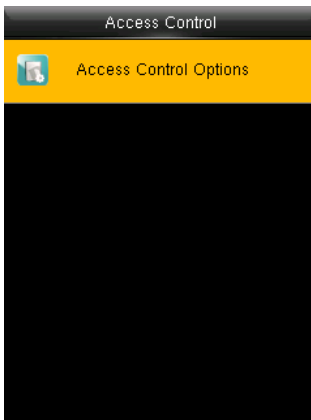

Access Control	
 Access Control Options	

Access Control Options: Includes Door Lock Delay.

System interfaces

3. Comm setting

Go to Main Menu→Comm.

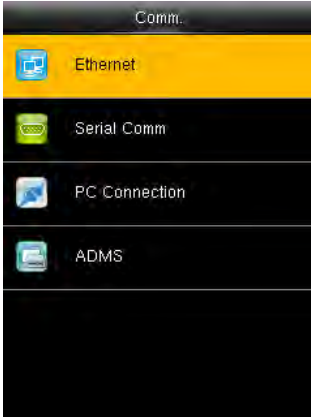

Ethernet: The device can communicate with PC via the Ethernet parameters.

Serial Comm: The device can communicate with PC via the serial port according to the user defined parameters.

PC Connection: Set the password and device ID so that you can connect the device with software in PC.

ADMS: Settings used for connecting with ADMS server.

4. Verification

➤ 1:1 Fingerprint verification mode ★

The device compares current fingerprint with the entered user ID.
Enter User ID and press fingerprint.

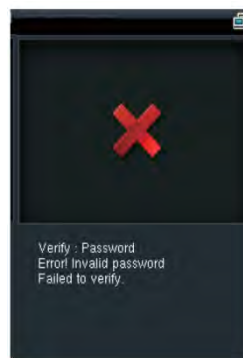
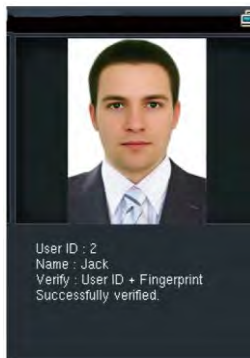

★ NOT ALL THE DEVICES HAS THIS FEATURE.

System interfaces

➤ 1:1 Face verification mode

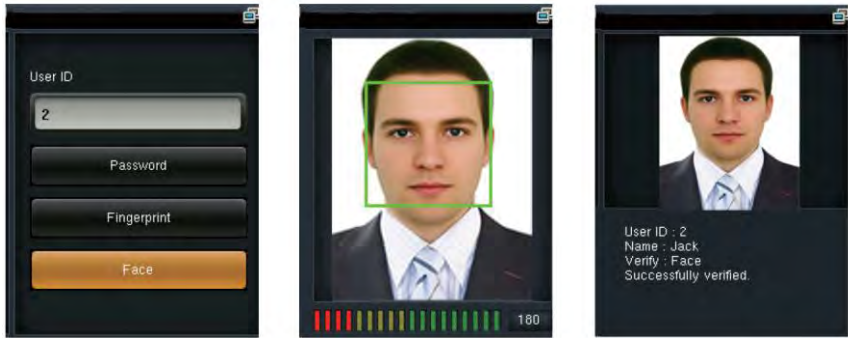

➤ Password verification



➤ Badge verification

Swipe your registered badge over the fingerprint sensor in standby mode. The device "prompts" "Duplicated Punch" when you swipe badge twice. The device prompts "Ou-Ou" when the badge is unregistered.

System interfaces

5. Attendance Record

Go to Main Menu→Attendance search→Attendance record

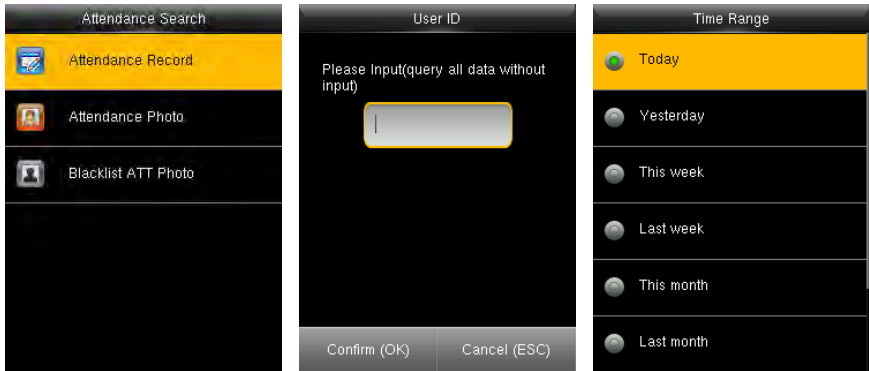

Enter the User ID and then select the time range for which attendance is required.

6. Attendance record on PC

Go to Main Menu→USB manager→Download→Attendance data

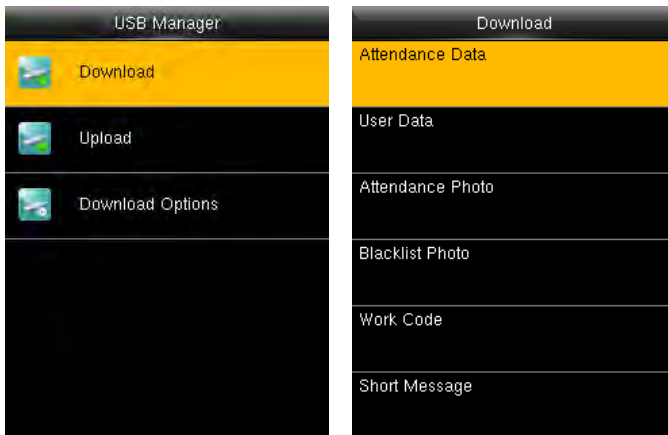

- Insert the USB disk correctly.
- Download the attendance data to the disk

System interfaces

- c. Then upload data from the disk to your computer. The downloaded data file is "Device Serial Number.dat". You can open it to view.

7. Backup data

To prevent data loss, you can back up the data to local drive or USB disk at any time.

Go to Main Menu → Data Mgt. → Backup Data → Select the required content

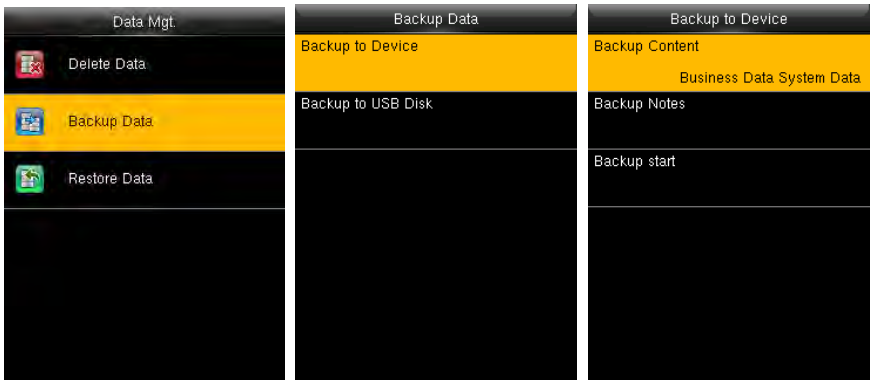

8. Some miscellaneous settings

Go to Main Menu → System → Date time

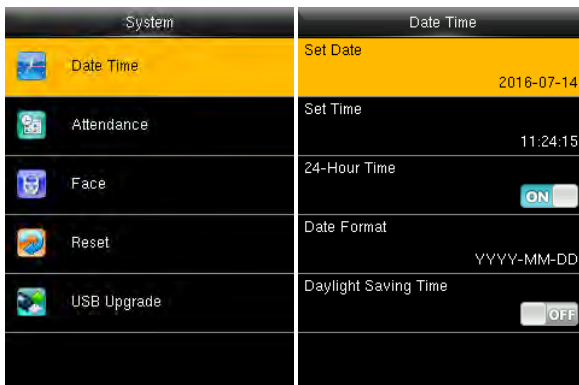

System interfaces

Go to Main Menu→System→Work Code→New Work Code

Work Code	New Work Code
New Work Code	ID 1
All Work Codes	Name
Work Code Options	

Go to Main Menu→System→Short Message

Short Message	New Message	Message
New Message	Message	Wmj
Public Messages	Start Date 2016-07-14	
Personal Messages	Start Time 14:03	
Drafts Messages	Expired Time (m) 60	
Message Options	Message Type Draft	[Aa]

9. Troubleshooting

- a. The face is not recognized by the device while verification.

Solution:

- ✓ Check out if the expressions or standing postures and distance is same in enrolling and verifying.
- ✓ Check out if the sunlight is direct to the device or if the device is near to the windows.

- b. User hasn't worn glasses while enrolling and wear glasses while verifying.

Solution:

- ✓ You can enroll face wearing glasses during the first or second catching face as the device supports 3 times to catch the face templates.

- c. The device make a misjudgment while verification.

Solution:

- ✓ There is a certain probability of misjudgment, you can re-enroll the face.

ZK Building, Wuhe Road, Gangtou, Bantian,
Buji Town, Longgang District, Shenzhen
China 518129
Tel:+86 755-89602345
Fax:+86 755-89602394
www.zkteco.com



© Copyright 2016. ZKTeco Inc. ZKTeco Logo is a registered trademark of ZKTeco or a related company. All other product and company names mentioned are used for identification purposes only and may be the trademarks of their respective owners. All specifications are subject to change without notice. All rights reserved.